



東成五金有限公司
TUNG SHING HARDWARE CO., LTD.

寫字樓：九龍觀塘成業街 16 號怡生工業中心 C 座 11 樓
電話：(852) 2626 9983 傳真：(852) 2626 9357

門市部：九龍旺角新填地街 249-253 號地舖
九龍大角咀福全街 17-19 號福康大樓地下 J 舖

貨倉部：九龍油塘灣四山街 14 號大益貨倉地庫

Website : www.tungshinghardware.com.hk

Ductile Iron Grooved Fittings and Couplings

To Provide **Safe & Reliable** Products and **Smart & Complete**
Solutions for Clients in Fluid Conveying Industry Across the Globe.





More than
50 years of
Foundry
Experience

Company History



Business Started from Grey Iron Pot



1961

Malleable Iron Pipe Fittings



1970

Export, Main Market: Southeast Asia



1987

Conduit Body



1990

Self Export, Developed US and European Market



1995

Cast Iron Fittings



1997

Steel Pipe Nipples
Red Brass Pipe Nipples

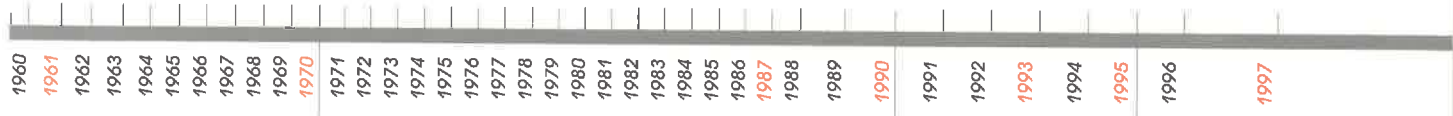

Company Profile

Jinan Meide Casting Co. Ltd. was established in 1961. In the past decades, Jinan Meide has seized each opportunity to consolidate its strength, and has finally developed into what it is today, a large-scale enterprise group with advanced technology, equipment and strong comprehensive strength, known for its complete range of products, large producing capacity, high quality and strong R&D strength. The company owns altogether one main factory, three branch factories, two independent accounting steel pipe companys, and a science & technology park.

The company is the well-known manufacturer in the fitting industry with the most complete range of products, supplying malleable iron fittings, grooved fittings, grooved couplings, valves, cast iron fittings, ductile iron fittings, steel pipe nipples and couplings, stainless steel nipples, brass pipe nipples, cast bronze fittings, steel pipes, pipe hangers and supports, electric fittings, etc.

Over 50 years, Jinan Meide has been a trusted name in piping solutions by offering high-quality products, service and support to the PVF industry continuously. We provide expertise and product solutions for a wide range of applications, plumbing, mechanical, industrial, air-conditioning and refrigeration, mining, oil, gas, fire protection, equipment and power system. Many of the company's application technology are advanced in the world, with more than 20 patents registered each year, and the company has presided over and participated in the drafting of many important national standards of the industry.

We organize the whole production process in accordance with ISO 9001 and ISO 14001. It has also the most complete certificates in the PVF industry, including UL/FM/NSF of US, CRN/cUL of Canada, DVGW/TUV/CE/VdS of Germany, BSI/LPCB of UK, SII of Israel, JIS of Japan, ABNT of Brazil, GOST-R of Russia, CNBOP of Poland, KS of South Korea, TSE of Turkey, PSB of Singapore, SIRIM of Malaysia, SABS of South Africa etc. The products are well distributed in more than 130 countries and regions.

As an industry leader and key high-tech enterprise of the national torch plan, the company attaches great importance to environmental protection, energy-saving and emission-reduction. US-EEC recognizes MECH brand malleable iron pipe fittings as "the product to promote for the technology exchange of environmental protection". Protecting the environment is the duty of the company.

Customer satisfaction has always been the company's top objective, and we constantly stick to the principle: to provide customers with a value-added solution rather than simply delivering products.



State of the Art Equipment

High precision equipment is quality assurance.

Jinan Meide's 8 factories are all equipped with the most advanced facilities and equipment in the industry. The main production facilities include Sinto automatic molding line, Tokyu automatic molding line, Chinese 416 automatic vertical molding line, automatic molding sand mixers, cupola furnaces, electric furnaces, water-cooled longevous cupola furnaces, CNC vertical machining centers, CNC machines, NC vertical lathes, radial drills, Jinan Meide proprietary automatic machines, hot-dipped galvanization line, automatic box sealing line, stereoscopic warehouse and so on.



Pattern



Tokyu AMF-111055



Pouring



Warehouse



Core Making



Sand Mulling



Melting



Sinto FCMX



DISA



End Grinding Line



Electrophoretic Coating



Threading, Air Pressure Test, and Anti-rust Treatment



Assembling

Reliable Quality Assurance

Jinan Meide is honored as the National enterprise technical center and is capable and qualified to conduct full series of tests and inspections including chemical checking, etc.

Inspection facilities include: spectrometer, carbon sulfur analyzer, metallurgical microscope, tensile strength testing equipment, pressure testing equipment, adhesive force testing equipment, CMM, hardness tester, etc.

From incoming inspection to finished product, quality is checked and monitored in the whole process. Each step of the manufacturing process is carefully documented, regularly reviewed for revision control and updating standard. Quality procedures are constantly monitored and updated to assure that only the highest and most consistent quality products are supplied to our valued customers.



3D Printer



Metallurgical Microscope



3D Scanner



Spectrometer



CMM



Projector



The Length of The Test Instrument



Roughness Tester



Carbon Sulfur Analyzer



Tensile Strength Testing Equipment



Sand Testing Instrument



Certificates



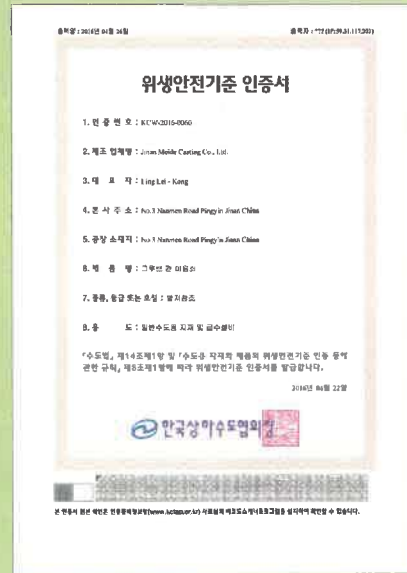
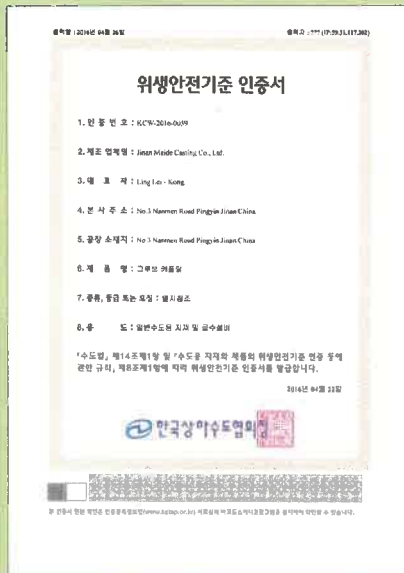
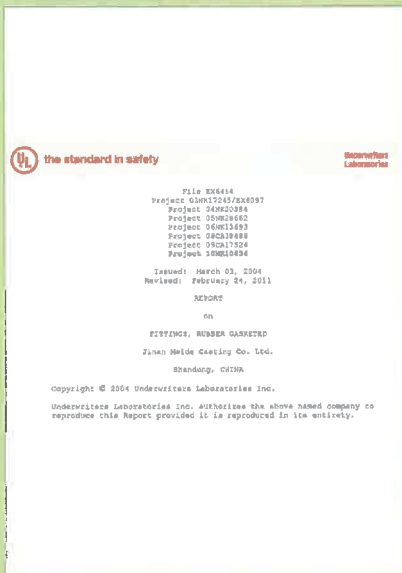

Ductile Iron Grooved Fittings and Couplings

 <p>1N Standard Flexible Coupling</p>	 <p>1N Standard Flexible Coupling</p>	 <p>1N Standard Reducing Flexible Coupling</p>	 <p>1NS Light-duty Flexible Coupling</p>	 <p>1NH Heavy-duty Flexible Coupling</p>
 <p>1G Standard Rigid Coupling</p>	 <p>1GS Light-duty Rigid Coupling</p>	 <p>1GK Angle Pad Coupling</p>	 <p>H305 HDPE Coupling</p>	 <p>H307 HDPE Transition Coupling</p>
 <p>90 90° Elbow</p>	 <p>90C 90° Hydrant Elbow</p>	 <p>90C 90° Drain Elbow</p>	 <p>90R 90° Reducing Elbow</p>	 <p>90S Light-duty 90° Elbow</p>
 <p>91R 90° END-ALL Elbow</p>	 <p>105 11.25° Elbow</p>	 <p>110 22.5° Elbow</p>	 <p>120 45° Elbow</p>	 <p>130 Tee</p>
 <p>130C Reducing tee</p>	 <p>130D Reducing tee</p>	 <p>130S Light-duty Tee</p>	 <p>130R Reducing Tee</p>	 <p>130R Reducing Tee</p>

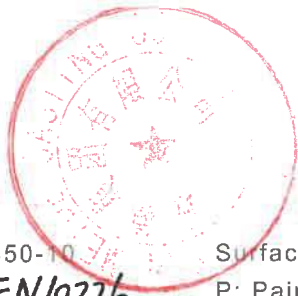

Material: ASTM A536, GRADE 65-45-12, QT450-10
 Threads: ASME B1.20.1, ISO 7-1, GB 7306, *EN10226*
 Size Available: 1"-24"

Surface Treatment:
 P: Painted E: Electroplated
 B: Black S: Epoxy G: Hot-dip Galvanized



1N

Standard Flexible Coupling

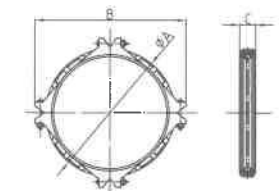
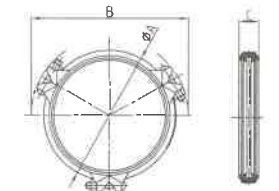
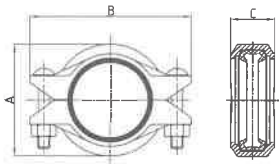

Nominal Size mm/in	Pipe O.D mm/in	Working Pressure PSI/MPa	Max. End Load kN/Lbs	Pipe End Separation mm/in	Dimensions			Bolt Size No.-Size mm	Certificate
					A mm/in	B mm/in	C mm/in		
25 1	33.7 1.327	500 3.45	3.0/680	0-1.6 0-0.06	55 2.16	92 3.62	42 1.65	2-3/8×55 2-M10×57	UL FM Vds LPCB
32 1¼	42.4 1.669	500 3.45	4.8/1080	0-1.6 0-0.06	65 2.56	104 4.14	44 1.74	2-3/8×55 2-M10×57	UL FM Vds LPCB
40 1½	48.3 1.900	500 3.45	6.3/1420	0-3.2 0-0.13	70 2.75	110 4.33	44 1.74	2-3/8×55 2-M10×57	UL FM Vds LPCB
50 2	60.3 2.375	500 3.45	9.8/2210	0-3.2 0-0.13	83 3.27	125 4.92	44 1.74	2-3/8×55 2-M10×57	UL FM Vds LPCB
65 2½	73.0 2.875	500 3.45	14.4/3240	0-3.2 0-0.13	96 3.78	143 5.63	45 1.78	2-3/8×55 2-M10×57	UL FM LPCB
65 2½	76.1 3.000	500 3.45	15.7/3520	0-3.2 0-0.13	100 3.94	145 5.71	45 1.78	2-3/8×55 2-M10×57	UL FM Vds LPCB
80 3	88.9 3.500	500 3.45	21.4/4810	0-3.2 0-0.13	115 4.53	160 6.30	45 1.78	2-1/2×70 2-M12×70	UL FM Vds LPCB
100 4	108.0 4.250	500 3.45	31.5/7100	0-3.2 0-0.13	138 5.43	190 7.48	50 1.97	2-1/2×70 2-M12×70	UL FM LPCB
100 4	114.3 4.500	500 3.45	35.4/7960	0-3.2 0-0.13	145 5.71	198 7.80	50 1.97	2-1/2×70 2-M12×70	UL FM Vds LPCB
125 5	133 5.250	300 2.07	28.7/6460	0-3.2 0-0.13	182 6.38	225 8.86	51.0 2.01	2-5/8×80 2-M16×85	UL FM LPCB
125 5	139.7 5.500	500 3.45	52.9/11800	0-3.2 0-0.13	189 6.65	230 9.06	52 2.05	2-5/8×80 2-M16×85	UL FM Vds LPCB
125 5	141.3 5.563	500 3.45	54.1/12100	0-3.2 0-0.13	170 6.69	232 9.13	51 2.01	2-5/8×80 2-M16×85	UL FM LPCB
150 6	159.0 6.250	300 2.07	41.0/9240	0-3.2 0-0.13	190 7.48	256 10.08	52 2.05	2-5/8×85 2-M16×85	UL FM LPCB
150 6	165.1 6.500	500 3.45	73.8/16610	0-3.2 0-0.13	196 7.72	260 10.24	52 2.05	2-5/8×85 2-M16×85	UL FM LPCB
150 6	168.3 6.625	500 3.45	76.7/17260	0-3.2 0-0.13	200 7.87	265 10.43	52 2.05	2-5/8×85 2-M16×85	UL FM Vds LPCB
200 8	216.3 8.516	300 2.07	76.0/17100	0-3.2 0-0.13	254 10.00	320 12.60	59 2.32	2-5/8×85 2-M16×85	UL FM
200 8	219.1 8.625	450 3.10	116.9/26280	0-3.2 0-0.13	258 10.24	342 13.46	60 2.37	2-3/4×115 2-M20×115	UL FM Vds LPCB
250 10	267.4 10.528	300 2.07	116.2/26140	0-3.2 0-0.13	308.5 12.15	403 15.87	64 2.52	2-3/4×115 2-M20×115	UL FM
250 10	273.0 10.750	300 2.07	121.0/27210	0-3.2 0-0.13	337 13.27	406 16.00	65 2.56	2-7/8×140 2-M22×140	UL FM Vds
300 12	318.5 12.539	300 2.07	164.8/37090	0-3.2 0-0.13	363 14.29	460 18.11	63 2.48	2-7/8×140 2-M22×140	UL FM
300 12	323.9 12.750	300 2.07	170.3/38280	0-3.2 0-0.13	378 14.96	485 18.31	65 2.56	2-7/8×140 2-M22×140	UL FM
350 14	355.6 14.000	300 2.07	205.5/46220	0-3.2 0-0.13	402 15.83	493 19.41	72 2.83	3-7/8×140 3-M22×140	—
350 14	377.0 14.843	225 1.6	178.5/40160	0-3.2 0-0.13	428 16.85	520 20.45	72 2.85	3-7/8×140 3-M22×140	—
400 16	406.4 16.000	300 2.07	268.4/60370	0-3.2 0-0.13	458 18.03	547 21.54	72 2.85	3-7/8×140 3-M22×140	—
400 16	426.0 16.772	225 1.6	227.9/51270	0-3.2 0-0.13	476 18.74	566 22.28	73 2.87	3-7/8×140 3-M22×140	—
450 18	457.2 18.000	300 2.07	262.5/59060	0-3.2 0-0.13	505 19.88	598 23.54	78 3.07	3-7/8×140 3-M22×140	—
500 20	508.0 20.000	300 2.07	324.1/72910	0-3.2 0-0.13	550 21.65	648 25.51	78 3.07	4-7/8×140 4-M22×140	—
600 24	609.6 24.000	300 2.07	466.7/104990	0-3.2 0-0.13	662 26.06	774 30.47	78 3.07	4-1X140	—

1N

Standard Reducing Flexible Coupling

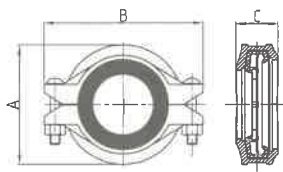

Nominal Size mm/in	Pipe O.D mm/in	Working Pressure PSI/MPa	Max. End Load kN/Lbs	Pipe End Separation mm/in	Dimensions			Bolt Size No.-Size mm	Certificate
					A mm/in	B mm/in	C mm/in		
50×40 2×1½	60.3×48.3 2.375×1.900	300 2.07	5.9/1330	0-3.2 0-0.13	86 3.39	125 4.93	44 1.74	2-3/8×55 2-M10×57	UL FM LPCB
65×25 2½×1	73.0×33.7 2.875×1.327	300 2.07	8.7/1950	0-3.2 0-0.13	100 3.94	138 5.44	45 1.78	2-3/8×55 2-M10×57	UL FM
65×50 2½×2	73.0×60.3 2.875×2.375	300 2.07	8.7/1950	0-3.2 0-0.13	100 3.94	138 5.43	45 1.78	2-3/8×55 2-M10×57	UL FM LPCB
65×25 2½×1	76.1×33.7 3.000×1.327	300 2.07	9.4/2120	0-3.2 0-0.13	102 4.02	140 5.51	45 1.78	2-3/8×55 2-M10×57	UL FM
65×40 2½×1½	76.1×48.3 3.000×1.900	300 2.07	9.4/2120	0-3.2 0-0.13	102 4.02	140 5.51	45 1.78	2-3/8×55 2-M10×57	UL FM LPCB
65×50 2½×2	76.1×60.3 3.000×2.375	300 2.07	9.4/2120	0-3.2 0-0.13	102 4.02	144 5.67	45 1.78	2-3/8×55 2-M10×57	UL FM Vds LPCB
80×25 3×1	88.9×33.7 3.500×1.327	300 2.07	12.8/2885	0-3.2 0-0.13	115 4.53	168 6.61	46 1.81	2-1/2×70 2-M12×70	UL FM
80×50 3×2	88.9×60.3 3.500×2.375	300 2.07	12.8/2885	0-3.2 0-0.13	115 4.53	168 6.61	46 1.81	2-1/2×70 2-M12×70	UL FM Vds LPCB
80×65 3×2½	88.9×73.0 3.500×2.875	300 2.07	12.8/2885	0-3.2 0-0.13	115 4.53	168 6.61	46 1.81	2-1/2×70 2-M12×70	UL FM LPCB
80×65 3×2½	88.9×76.1 3.500×3.000	300 2.07	12.8/2885	0-3.2 0-0.13	115 4.53	172 6.77	46 1.81	2-1/2×70 2-M12×70	UL FM Vds LPCB
100×25 4×1	114.3×33.7 4.500×1.327	300 2.07	21.2/4770	0-3.2 0-0.13	144 5.67	198 7.80	50 1.97	2-1/2×70 2-M12×70	UL FM
100×50 4×2	114.3×60.3 4.500×2.375	300 2.07	21.2/4770	0-3.2 0-0.13	144 5.67	198 7.80	50 1.97	2-1/2×70 2-M12×70	UL FM Vds LPCB
100×65 4×2½	114.3×73.0 4.500×2.875	300 2.07	21.2/4770	0-3.2 0-0.13	144 5.67	198 7.80	50 1.97	2-1/2×70 2-M12×70	UL FM LPCB
100×65 4×2½	114.3×76.1 4.500×3.000	300 2.07	21.2/4770	0-3.2 0-0.13	144 5.67	202 7.95	50 1.97	2-1/2×70 2-M12×70	UL FM Vds LPCB
100×80 4×3	114.3×88.9 4.500×3.500	300 2.07	21.2/4770	0-3.2 0-0.13	148 5.83	198 7.80	50 1.97	2-1/2×70 2-M12×70	UL FM Vds LPCB
150×80 6×3	165.1×88.9 6.500×3.500	300 2.07	44.3/9960	0-3.2 0-0.13	200 7.87	260 10.24	51 2.01	2-3/4×115 2-M20×115	—
150×100 6×4	165.1×114.3 6.500×4.500	300 2.07	44.3/9960	0-3.2 0-0.13	197 7.75	260 10.24	51 2.01	2-5/8×85 2-M16×85	UL FM LPCB
150×80 6×3	168.3×88.9 6.625×3.500	300 2.07	46.0/10340	0-3.2 0-0.13	200 7.87	269 10.55	51 2.01	2-5/8×85 2-M16×85	UL FM
150×100 6×4	168.3×114.3 6.625×4.500	300 2.07	46.0/10340	0-3.2 0-0.13	202.5 7.97	268 10.55	52.5 2.07	2-5/8×85 2-M16×85	UL FM Vds LPCB
150×150 6×6	168.3×165.1 6.625×6.500	300 2.07	46.0/10340	0-3.2 0-0.13	204 8.031	268 10.551	52.5 2.066	2-5/8×85 2-M16×85	—
200×150 8×6	219.1×165.1 8.625×6.500	300 2.07	77.8/17500	0-3.2 0-0.13	257 10.12	335 13.19	60 2.36	2-3/4×115 2-M20×115	UL FM LPCB
200×150 8×6	219.1×168.3 8.625×6.625	300 2.07	77.8/17500	0-3.2 0-0.13	260 10.24	338 13.31	60 2.36	2-3/4×115 2-M20×115	UL FM LPCB

1NH

Heavy-duty Flexible Coupling

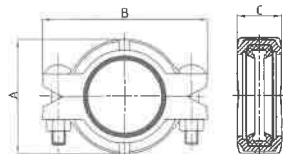
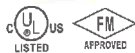

Nominal Size mm/in	Pipe O.D mm/in	Working Pressure PSI/MPa	Max. End Load kN/Lbs	Pipe End Separation mm/in	Dimensions			Bolt Size No.-Size mm	Certificate
					A mm/in	B mm/in	C mm/in		
50 2	60.3 2.375	750 5.17	14.8/3320	0-3.2 0-0.13	90 3.54	134 5.28	45 1.77	2-1/2X75 2-M12X76	UL FM
65 2½	73.0 2.875	750 5.17	21.6/4860	0-3.2 0-0.13	100 3.94	150 5.91	45 1.77	2-1/2X75 2-M12X76	UL FM
65 2½	76.1 3.000	750 5.17	23.5/5280	0-3.2 0-0.13	102 4.02	154 6.06	45 1.77	2-1/2X75 2-M12X76	UL FM
80 3	88.9 3.500	750 5.17	32.1/7210	0-3.2 0-0.13	121 4.76	172 6.78	45 1.77	2-1/2X75 2-M12X76	UL FM
100 4	114.3 4.500	750 5.17	53.0/11900	0-3.2 0-0.13	151 5.95	214 8.43	50 1.97	2-5/8X85 2-M16X85	UL FM
125 5	141.3 5.563	750 5.17	81.0/18200	0-3.2 0-0.13	180 7.09	248 9.76	51 2.00	2-3/4X115 2-M20X115	UL FM
150 6	165.1 6.500	750 5.17	110.6/24800	0-3.2 0-0.13	205 8.07	278 10.95	51 2.00	2-3/4X115 2-M20X115	UL FM
150 6	168.3 6.625	750 5.17	115.0/25800	0-3.2 0-0.13	208 8.20	284 11.18	51 2.00	2-3/4X115 2-M20X115	UL FM
200 8	219.1 8.625	750 5.17	194.8/43800	0-3.2 0-0.13	268 10.56	354 13.94	61 2.40	2-7/8X140 2-M22X140	UL FM

1NS

Light-duty Flexible Coupling

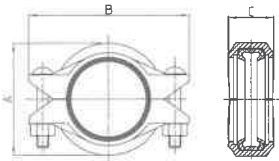
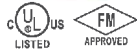

Nominal Size mm/in	Pipe O.D mm/in	Working Pressure PSI/MPa	Max. End Load kN/Lbs	Pipe End Separation mm/in	Dimensions			Bolt Size No.-Size mm	Certificate
					A mm/in	B mm/in	C mm/in		
100 4	114.3 4.500	300 2.07	21.2/4770	0-3.2 0-0.13	139 5.47	182 7.16	50 1.97	2-3/8X55 2-M10X57	UL FM
125 5	139.7 5.500	450 3.10	47.5/10680	0-3.2 0-0.13	168 6.61	228 8.98	51 2.01	2-5/8X80 2-M16X85	UL FM
165 6	165.1 6.500	300 2.07	44.3/9960	0-3.2 0-0.13	192 7.56	244 9.61	51 2.01	2-1/2X75 2-M12X76	UL FM
165 6	168.3 6.625	300 2.07	46.0/10340	0-3.2 0-0.13	200 7.87	266 10.47	52 2.05	2-5/8X85 2-M16X85	UL FM
250 10	273.0 10.750	300 2.07	121.0/27210	0-3.2 0-0.13	320 12.60	398.0 15.67	64 2.52	2-3/4X120 2-M20X115	UL FM

H305

HDPE Coupling

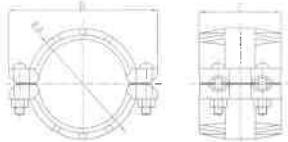

Nominal Size mm/in	Pipe O.D mm/in	Dimensions			Bolt Size No.-Size mm
		A mm/in	B mm/in	C mm/in	
50 2	60.3 2.375	86.5 3.406	133 5.24	116 4.567	4-1/2X70
80 3	88.9 3.5	118 4.65	165 6.5	116 4.567	4-1/2X75
100 4	114.3 4.5	148 5.827	202 7.953	146 5.75	4-1/2X75
150 6	168.3 6.625	203 7.99	273 10.75	149 5.87	4-5/8X85
200 8	219.1 8.625	263 10.35	333 13.11	152 5.98	4-5/8X85
250 10	273.0 10.75	321 12.65	399 15.709	165 6.496	4-3/4X120
300 12	323.9 12.75	372 14.656	452 17.795	185 7.28	4-3/4X120

H307

HDPE Transition Coupling

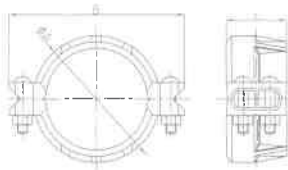

Nominal Size mm/in	Pipe O.D mm/in	Dimensions			Bolt Size No.-Size mm
		A mm/in	B mm/in	C mm/in	
50 2	60.3 2.375	86.5 3.406	147 5.787	79 3.11	4-1/2X70
80 3	88.9 3.5	116 4.567	176 6.929	79 3.11	4-1/2X75
100 4	114.3 4.5	148 5.827	209 8.228	95 3.75	4-1/2X75
150 6	168.3 6.625	202 7.95	280 11.02	95 3.74	4-5/8X85
200 8	219.1 8.625	264 10.39	342 13.46	107.5 4.23	4-5/8X85
250 10	273.0 10.75	321 12.65	424 16.693	127 5	4-3/4X120
300 12	323.9 12.75	372 14.656	483 19.016	127 5	4-3/4X120

1G

Standard Rigid Coupling

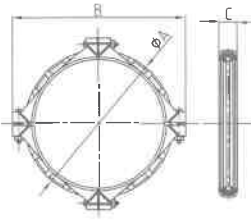
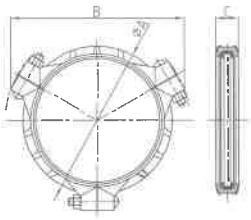
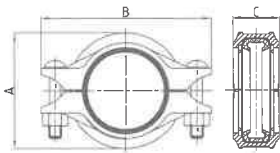

Nominal Size mm/in	Pipe O.D mm/in	Working Pressure PSI/MPa	Max. End Load kN/Lbs	Pipe End Separation mm/in	Dimensions			Bolt Size No.-Size mm	Certificate
					A mm/in	B mm/in	C mm/in		
25 1	33.7 1.327	500 3.45	3.0/680	0-1.6 0-0.06	59 2.33	100 3.94	44 1.74	2-3/8X55 2-M10X57	UL FM Vds LPCB
32 1 1/4	42.4 1.669	500 3.45	4.8/1080	0-1.6 0-0.06	66 2.60	109.5 4.31	45 1.78	2-3/8X55 2-M10X57	UL FM Vds LPCB
40 1 1/2	48.3 1.900	500 3.45	6.3/1420	0-3.2 0-0.13	72 2.84	115 4.53	45 1.78	2-3/8X55 2-M10X57	UL FM Vds LPCB
50 2	60.3 2.375	500 3.45	9.8/2210	0-3.2 0-0.13	85 3.35	131 5.16	45 1.78	2-3/8X55 2-M10X57	UL FM Vds LPCB
65 2 1/2	73.0 2.875	500 3.45	14.4/3240	0-3.2 0-0.13	98 3.86	145 5.71	45 1.78	2-3/8X55 2-M10X57	UL FM LPCB
65 2 1/2	76.1 3.000	500 3.45	15.7/3520	0-3.2 0-0.13	101 3.98	147 5.78	45 1.77	2-3/8X55 2-M10X57	UL FM Vds LPCB
80 3	88.9 3.500	500 3.45	21.4/4810	0-3.2 0-0.13	115.0 4.53	170 6.69	46 1.82	2-1/2X70 2-M12X70	UL FM Vds LPCB
100 4	108.0 4.250	500 3.45	31.5/7100	0-3.2 0-0.13	140 5.51	197 7.76	52 2.05	2-1/2X70 2-M12X70	UL FM LPCB
100 4	114.3 4.500	500 3.45	35.4/7960	0-3.2 0-0.13	146 5.75	200 7.88	52 2.05	2-1/2X70 2-M12X70	UL FM Vds LPCB
125 5	133 5.250	300 2.07	28.7/6460	0-3.2 0-0.13	165 6.50	232 9.13	52 2.05	2-5/8X85 2-M16X85	UL FM LPCB
125 5	139.7 5.500	500 3.45	52.9/11800	0-3.2 0-0.13	170 6.69	238 9.37	52 2.05	2-5/8X85 2-M16X85	UL FM Vds LPCB
125 5	141.3 5.563	500 3.45	54.1/12100	0-3.2 0-0.13	172 6.77	236.5 9.31	52 2.05	2-5/8X85 2-M16X85	UL FM LPCB
150 6	159.0 6.250	300 2.07	41.0/9240	0-3.2 0-0.13	190 7.48	258 10.16	52 2.05	2-5/8X85 2-M16X85	UL FM LPCB
150 6	165.1 6.500	500 3.45	73.8/16610	0-3.2 0-0.13	198 7.80	266 10.47	52 2.05	2-5/8X85 2-M16X85	UL FM LPCB
150 6	168.3 6.625	500 3.45	76.7/17260	0-3.2 0-0.13	202.0 7.95	270 10.63	52 2.05	2-5/8X85 2-M16X85	UL FM Vds LPCB
200 8	219.1 8.625	450 3.10	116.9/26280	0-3.2 0-0.13	260.0 10.24	346 13.625	62 2.44	2-3/4X115 2-M20X115	UL FM Vds LPCB
250A 10	267.4 10.528	300 2.07	116/26130	0-3.2 0-0.13	318 12.52	386 15.60	63 2.48	2-3/4X120 2-M20X115	UL FM
250 10	273.0 10.750	400 2.8	163.8/36800	0-3.2 0-0.13	327 12.88	420 16.54	63 2.48	2-7/8X125 2-M22X125	UL FM Vds
300A 12	318.5 12.539	300 2.07	164.8/37080	0-3.2 0-0.13	364 14.33	456 17.95	63 2.48	2-7/8X140 2-M22X140	UL FM
300 12	323.9 12.750	400 2.8	230.6/51880	0-3.2 0-0.13	378 14.88	466 18.35	63 2.48	2-7/8X140 2-M22X140	UL FM
350 14	355.6 14.000	300 2.07	205.5/46220	0-3.2 0-0.13	415 16.34	510 20.08	72 2.84	3-7/8X140 3-M22X140	UL FM
400 16	406.4 16.000	300 2.07	268.4/60370	0-3.2 0-0.13	468 18.43	575 22.64	72 2.84	3-7/8X140 3-M22X140	UL FM
450 18	457.2 18.000	225 1.6	262.5/59060	0-3.2 0-0.13	508 20	608 23.94	78 3.07	3-7/8X140 3-M22X140	—
500 20	508.0 20.0	225 1.6	324.1/72910	0-3.2 0-0.13	563 22.17	660 25.98	78 3.07	4-7/8X140 4-M22X140	—
600 24	609.6 24.000	225 1.6	466.7/104990	0-3.2 0-0.13	668 26.30	772 30.40	78 3.07	4-1X140	—

1GS

Light-duty Rigid Coupling

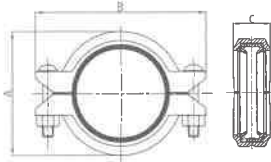

Nominal Size mm/in	Pipe O.D mm/in	Working Pressure PSI/MPa	Max. End Load kN/Lbs	Pipe End Separation mm/in	Dimensions			Bolt Size No. Size mm	Certificate
					A mm/in	B mm/in	C mm/in		
80 3	88.9 3.500	350 2.41	15.0/3360	0-3.2 0-0.13	114 4.50	160 6.30	45 1.78	2-3/8X55 2-M10X57	UL FM VdS LPCB
100 4	108.0 4.250	300 2.07	18.9/4260	0-3.2 0-0.13	135 5.30	185 7.28	50 1.97	2-1/2X70 2-M12X70	UL FM LPCB
100 4	114.3 4.500	350 2.41	24.7/5560	0-3.2 0-0.13	140 5.51	192 7.56	46.5 1.83	2-1/2X70 2-M12X70	UL FM VdS LPCB
125 5	139.7 5.500	350 2.41	36.9/8300	0-3.2 0-0.13	168 6.62	225 8.86	50 1.97	2-1/2X75 2-M12X76	UL FM LPCB
125 5	141.3 5.563	350 2.41	37.8/8490	0-3.2 0-0.13	170 6.69	225 8.86	50 1.97	2-1/2X75 2-M12X76	UL FM LPCB
150 6	159.0 6.250	300 2.07	41.0/9240	0-3.2 0-0.13	190 7.48	252 9.92	50 1.97	2-5/8X80 2-M16X85	UL FM LPCB
150 6	165.1 6.500	350 2.41	51.6/11600	0-3.2 0-0.13	195 7.68	250 9.84	50 1.97	2-1/2X75 2-M12X76	UL FM LPCB
150 6	168.3 6.625	350 2.41	53.6/12000	0-3.2 0-0.13	200 7.87	255 10.04	50 1.97	2-1/2X75 2-M12X76	UL FM LPCB
200A 8	216.3 8.516	300 2.07	76.0/17100	0-3.2 0-0.13	255 10.04	320 12.60	58 2.28	2-5/8X85 2-M16X85	UL FM
200 8	219.1 8.625	350 2.41	90.8/20430	0-3.2 0-0.13	255 10.05	324 12.76	58 2.28	2-5/8X85 2-M16X85	UL FM LPCB
250 10	273.0 10.750	300 2.07	121.0/27210	0-3.2 0-0.13	318 12.52	410 16.14	63 2.48	2-3/4X110 2-M20X115	UL FM

1GK

Angle Pad Coupling

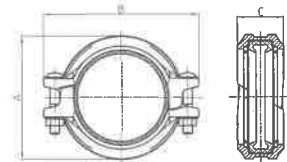

Nominal Size mm/in	Pipe O.D mm/in	Working Pressure PSI/MPa	Max. End Load kN/Lbs	Pipe End Separation mm/in	Dimensions			Bolt Size No. Size mm	Certificate
					A mm/in	B mm/in	C mm/in		
32 1 1/4	42.4 1.689	500 3.45	4.8/1080	0-1.6 0-0.06	64 2.52	99 3.90	46.5 1.83	2-M10X55	UL FM
40 1 1/2	48.3 1.900	500 3.45	6.3/1420	0-3.2 0-0.13	70 2.76	105 4.13	46.5 1.83	2-M10X55	UL FM
50 2	60.3 2.375	500 3.45	9.8/2210	0-3.2 0-0.13	85 3.35	121 4.76	46.5 1.83	2-M10X55	UL FM
65 2 1/2	73.0 2.875	300 2.07	8.7/1950	0-3.2 0-0.13	99 3.90	134 5.28	47.5 1.87	2-M10X63	UL FM
65 2 1/2	76.1 3.000	500 3.45	15.7/3520	0-3.2 0-0.13	102 4.02	137 5.39	47.5 1.87	2-M10X63	UL FM
80 3	88.9 3.500	500 3.45	21.4/4810	0-3.2 0-0.13	115 4.53	150 5.91	47.5 1.87	2-M10X80	UL FM
100 4	114.3 4.500	500 3.45	35.4/7960	0-3.2 0-0.13	142 5.59	180 7.09	50 1.97	2-M10X85	UL FM
125 5	139.7 5.500	300 2.07	31.7/7130	0-3.2 0-0.13	171 6.73	214 8.43	52.5 2.07	2-M12X75	UL FM
150 6	165.1 6.500	300 2.07	44.3/9960	0-3.2 0-0.13	198 7.80	242 9.53	52.5 2.07	2-M12X75	UL FM
150 6	168.3 6.625	300 2.07	46.0/10340	0-3.2 0-0.13	201 7.91	245 9.65	52.5 2.07	2-M12X75	UL FM
200 8	219.1 8.625	300 2.07	77.8/17500	0-3.2 0-0.13	258 10.16	331 13.03	63.5 2.50	2-M20X110	UL FM
250 10	273.0 10.750	300 2.07	121.0/27210	0-3.2 0-0.13	321 12.64	406 15.98	64.5 2.54	2-M22X140	UL

90

90° Elbow

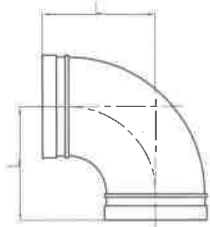

Nominal Size mm/in	Pipe O.D. mm/in	Working Pressure PSI/MPa	Dimensions L mm/in	Certificate
25 1	33.7 1.315	500 3.45	57 2.24	UL FM VdS LPCB
32 1¼	42.4 1.680	500 3.45	70 2.75	UL FM VdS LPCB
40 1½	48.3 1.900	500 3.45	70 2.75	UL FM VdS LPCB
50 2	60.3 2.375	500 3.45	82.5 3.25	UL FM VdS LPCB
65 2½	73.0 2.875	500 3.45	95 3.74	UL FM
65 2½	76.1 3.000	500 3.45	95 3.74	UL FM VdS LPCB
80 3	88.9 3.500	500 3.45	108 4.25	UL FM VdS LPCB
100 4	114.3 4.500	500 3.45	127 5.00	UL FM VdS LPCB
125 5	133.0 5.250	500 3.45	122 4.80	UL FM
125 5	139.7 5.500	500 3.45	140 5.50	UL FM VdS LPCB
125 5	141.3 5.563	500 3.45	140 5.50	UL FM
150 6	165.1 6.500	500 3.45	165 6.50	UL FM LPCB
150 6	168.3 6.625	500 3.45	165 6.50	UL FM VdS LPCB
200 8	219.1 8.625	500 3.45	197 7.75	UL FM VdS LPCB
250 10	267.4 10.528	300 2.07	229 9.00	UL FM
250 10	273.0 10.750	300 2.07	229 9.00	UL FM VdS
300 12	318.5 12.539	300 2.07	264 10.00	UL FM
300 12	323.9 12.750	300 2.07	254 10.00	UL FM VdS
350 14	355.6 14.000	300 2.07	280 11.02	—
350 14	377.0 14.84	300 2.07	279 10.98	—
400 16	406.4 16.000	300 2.07	305 12.00	—
400 16	426.0 16.77	300 2.07	305 12.00	—
450 18	457.2 18.000	300 2.07	394 15.50	—
450 18	480.0 18.90	300 2.07	335 13.19	—
500 20	508.0 20.000	300 2.07	438 17.25	—
600 24	609.6 24.000	300 2.07	508 20.00	—

90C

90° Hydrant Elbow

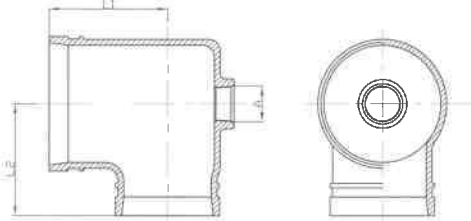

Nominal Size mm/in	Pipe O.D mm/in	Working Pressure PSI/MPa	Dimensions			Certificate
			A	L 1 mm/in	L 2 mm/in	
100X80X25 4X3X1	114.3X88.9X33.7 4.500X3.500X1.327	300 2.07	1-11.5NPT Rp1-ISO7/1	102 4.016	95 3.74	UL FM
150x80X25 6X3X1	165.1X88.9X33.7 6.500X3.500X1.327	300 2.07	1-11.5NPT Rp1-ISO7/1	130 5.118	130 5.118	UL FM

90C

90° Drain Elbow



Nominal Size mm/in	Pipe O.D mm/in	Working Pressure PSI/MPa	Dimensions			Certificate
			L mm/in	D mm/in	E mm/in	
50 2	60.3 2.375	300 2.07	82.5 3.248	57 2.244	40 1.575	—
65 2 1/2	73 2.875	300 2.07	95 3.74	70 2.756	43 1.693	—
80 3	88.9 3.500	300 2.07	108 4.25	70 2.756	53 2.087	—
100 4	114.3 4.5	300 2.07	127 5	70 2.756	66 2.598	—
150 6	168.3 6.625	300 2.07	165 6.496	70 2.756	93 3.661	—
200 8	219.1 8.625	300 2.07	197 7.756	70 2.756	126 4.961	—

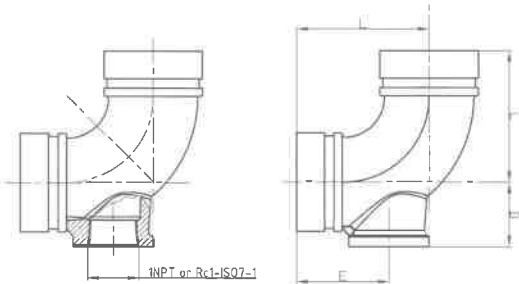

90R

90° Reducing Elbow

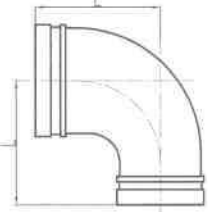

Nominal Size mm/in	Pipe O.D. mm/in	Working Pressure PSI/MPa	Dimensions L mm/in	Certificate
80X65 3X2 1/2	88.9X76.1 3.500X3.000	500 3.45	108 4.25	UL FM
100X65 4X2 1/2	114.3X76.1 4.500X3.000	500 3.45	127 5.00	UL FM
100X80 4X3	114.3X88.9 4.500X3.500	500 3.45	127 5.00	UL FM
150X100 6X4	165.1X114.3 6.500X4.500	500 3.45	165 6.50	UL FM
150X100 6X4	168.3X114.3 6.625X4.500	500 3.45	165 6.50	UL FM

90S

Light-duty 90° Elbow

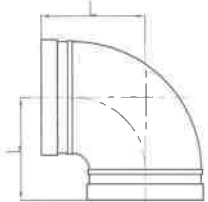

Nominal Size mm/in	Pipe O.D. mm/in	Working Pressure PSI/MPa	Dimensions L mm/in	Certificate
50 2	60.3 2.375	300 2.07	70 2.75	UL FM VdS LPCB
65 2 1/2	73.0 2.875	300 2.07	76 3.00	UL FM
65 2 1/2	76.1 3.000	300 2.07	76 3.00	UL FM VdS LPCB
80 3	88.9 3.500	300 2.07	85.5 3.37	UL FM VdS LPCB
100 4	108.0 4.500	500 3.45	101 3.98	UL FM
100 4	114.3 4.500	365 2.52	101 3.98	UL FM VdS LPCB
125 5	139.7 5.500	300 2.07	124 4.88	UL FM VdS LPCB
150 6	159.0 6.500	300 2.07	140 5.50	UL FM
150 6	165.1 6.500	365 2.52	140 5.50	UL FM LPCB
150 6	168.3 6.625	300 2.07	140 5.50	UL FM VdS LPCB
200 8	216.3 8.625	300 2.07	175 6.89	UL FM
200 8	219.1 8.625	300 2.07	165 6.50	UL FM VdS LPCB

91R

90° END-ALL Elbow

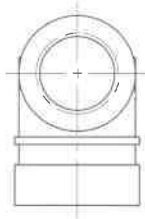
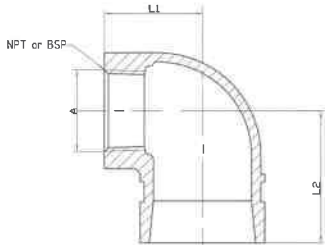

Nominal Size mm/in	Pipe O.D. mm/in	Working Pressure PSI/MPa	Dimensions			Certificate
			A (NPT/BSP)	L1 mm/in	L2 mm/in	
32X15 1 1/4X1/2	42.4X21.3 1.660X0.825	300 2.07	1/2	35.1 1.382	44.5 1.752	UL
32X20 1 1/4X3/4	42.4X26.9 1.660X1.050	300 2.07	3/4	34.9 1.374	47.6 1.874	UL
32X25 1 1/4X1	42.4X33.7 1.660X1.315	300 2.07	1	38.1 1.5	51.6 2.031	UL
40X15 1 1/2X1/2	48.3X21.3 1.900X0.825	300 2.07	1/2	34.9 1.374	44.5 1.752	UL
40X20 1 1/2X3/4	48.3X26.9 1.900X1.050	300 2.07	3/4	34.9 1.374	47.6 1.874	UL
40X25 1 1/2X1	48.3X33.7 1.900X1.315	300 2.07	1	38.1 1.5	51.6 2.031	UL
50X15 2X1/2	60.3X21.3 2.375X0.825	300 2.07	1/2	41.4 1.63	44.5 1.752	UL
50X20 2X3/4	60.3X26.9 2.375X1.050	300 2.07	3/4	41.3 1.626	47.6 1.874	UL
50X25 2X1	60.3X33.7 2.375X1.315	300 2.07	1	44.5 1.752	51.6 2.031	UL
65X15 2 1/2X1/2	73.0X21.3 2.875X0.825	300 2.07	1/2	46 1.811	44.5 1.752	UL
65X20 2 1/2X3/4	73.0X26.9 2.875X1.050	300 2.07	3/4	46 1.811	47.6 1.874	UL
65X25 2 1/2X1	73.0X33.7 2.875X1.315	300 2.07	1	49.2 1.937	51.6 2.031	UL
80X20 3X3/4	88.9X26.9 3.500X1.050	300 2.07	3/4	60.3 2.374	52.4 2.063	UL
80X25 3X1	88.9X33.7 3.500X1.315	300 2.07	1	63.5 2.5	52.4 2.063	UL

105

11.25° Elbow

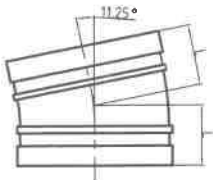

Nominal Size mm/in	Pipe O.D mm/in	Working Pressure PS/MPa	Dimensions L mm/in	Certificate
32 1 1/4	42.4 1.680	500 3.45	35 1.38	UL FM
40 1 1/2	48.3 1.900	500 3.45	35 1.38	UL FM
50 2	60.3 2.375	500 3.45	35 1.38	UL FM VdS LPCB
65 2 1/2	73.0 2.875	500 3.45	38 1.506	UL FM
65 2 1/2	76.1 3.000	500 3.45	38 1.506	UL FM VdS LPCB
80 3	88.9 3.500	500 3.45	38 1.50	UL FM VdS LPCB
100 4	108.0 4.250	500 3.45	44 1.73	UL FM
100 4	114.3 4.500	500 3.45	44 1.73	UL FM VdS LPCB
125 5	139.7 5.500	500 3.45	51 2.00	UL FM VdS LPCB
150 6	159.0 6.250	500 3.45	51 2.00	UL FM
150 6	165.1 6.500	500 3.45	51 2.00	UL FM LPCB
150 6	168.3 6.625	500 3.45	51 2.00	UL FM VdS
200 8	219.1 8.625	500 3.45	51 2.00	UL FM VdS LPCB

110

22.5° Elbow

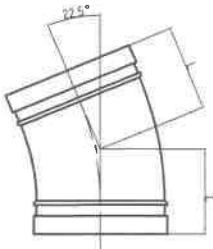

Nominal Size mm/in	Pipe O.D mm/in	Working Pressure PS/MPa	Dimensions L mm/in	Certificate
32 1 1/4	42.4 1.660	500 3.45	45 1.77	UL FM
40 1 1/2	48.3 1.900	500 3.45	45 1.77	UL FM
50 2	60.3 2.375	500 3.45	48 1.89	UL FM
65 2 1/2	73.0 2.875	500 3.45	51 2.00	UL FM
65 2 1/2	76.1 3.000	500 3.45	51 2.00	UL FM VdS LPCB
80 3	88.9 3.500	500 3.45	57 2.24	UL FM VdS LPCB
100 4	108.0 4.250	500 3.45	73 2.87	UL FM
100 4	114.3 4.500	500 3.45	73 2.87	UL FM VdS LPCB
125 5	139.7 5.500	500 3.45	73 2.87	UL FM VdS LPCB
150 6	159.0 6.250	500 3.45	79 3.11	UL FM
150 6	165.1 6.500	500 3.45	79 3.11	UL FM LPCB
150 6	168.3 6.625	500 3.45	79 3.11	UL FM VdS
200 8	219.1 8.625	500 3.45	98 3.86	UL FM VdS LPCB

120

45° Elbow

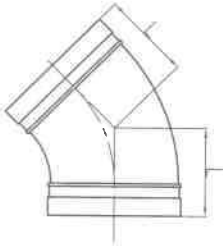

Nominal Size mm/in	Pipe O.D mm/in	Working Pressure PSI/MPa	Dimensions L mm/in	Certificate
25 1	33.7 1.315	500 3.45	44.5 1.75	UL FM VdS LPCB
32 1¼	42.4 1.660	500 3.45	44.5 1.75	UL FM VdS LPCB
40 1½	48.3 1.900	500 3.45	44.5 1.75	UL FM VdS LPCB
50 2	60.3 2.375	500 3.45	51 2.00	UL FM VdS LPCB
65 2½	73.0 2.875	500 3.45	57 2.24	UL FM
65 2½	76.1 3.000	500 3.45	57 2.24	UL FM VdS LPCB
80 3	88.9 3.500	500 3.45	63.5 2.50	UL FM VdS LPCB
100 4	108.0 4.250	500 3.45	76 3.00	UL FM
100 4	114.3 4.500	500 3.45	76 3.00	UL FM VdS LPCB
125 5	133.0 5.250	500 3.45	82.5 3.25	—
125 5	139.7 5.500	500 3.45	82.5 3.25	UL FM VdS LPCB
125 5	141.3 5.563	500 3.45	82.5 3.25	UL FM
150 6	159.0 6.250	500 3.45	89 3.50	UL FM
150 6	165.1 6.500	500 3.45	89 3.50	UL FM LPCB
150 6	168.3 6.625	500 3.45	89 3.50	UL FM VdS LPCB
200 8	216.3 8.516	500 3.45	108 4.25	UL FM
200 8	219.1 8.625	500 3.45	108 4.25	UL FM VdS LPCB
250 10	267.4 10.528	300 2.07	120.5 4.75	UL FM
250 10	273.0 10.750	500 3.45	120.5 4.75	UL FM VdS
300 12	318.5 12.750	300 2.07	133 5.25	UL FM
300 12	323.9 12.750	500 3.45	133 5.25	UL FM VdS
350 14	377 14.843	300 2.07	122 4.80	—
350 14	355.6 14.000	300 2.07	152 6.00	—
400 16	406.4 16.000	300 2.07	184 7.25	—
450 18	457.2 18.000	300 2.07	203 8.00	—
500 20	508.0 20.000	300 2.07	229 9.00	—
600 24	609.6 24.000	300 2.07	280 11.00	—

130

Tee

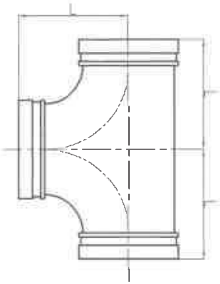

Nominal Size mm/in	Pipe O.D mm/in	Working Pressure PSUMPa	Dimensions L mm/in	Certificate
25 1	33.7 1.315	500 3.45	57 2.24	UL FM VdS LPCB
32 1¼	42.4 1.660	500 3.45	70 2.75	UL FM VdS LPCB
40 1½	48.3 1.900	500 3.45	70 2.75	UL FM VdS LPCB
50 2	60.3 2.375	500 3.45	82.5 3.25	UL FM VdS LPCB
65 2½	73.0 2.875	500 3.45	95 3.74	UL FM
65 2½	76.1 3.000	500 3.45	95 3.74	UL FM VdS LPCB
80 3	88.9 3.500	500 3.45	108 4.25	UL FM VdS LPCB
100 4	114.3 4.500	500 3.45	127 5.00	UL FM VdS LPCB
125 5	133.0 5.250	500 3.45	122 4.80	UL FM
125 5	139.7 5.500	500 3.45	140 5.50	UL FM VdS LPCB
125 5	141.3 5.583	500 3.45	140 5.50	UL FM
150 6	165.1 6.500	500 3.45	165 6.50	UL FM LPCB
150 6	168.3 6.625	500 3.45	165 6.50	UL FM VdS LPCB
200 8	219.1 8.625	500 3.45	197 7.75	UL FM VdS LPCB
250 10	267.4 10.528	500 3.45	229 9.00	UL FM
250 10	273.0 10.750	500 3.45	229 9.00	UL FM VdS
300 12	318.5 12.539	500 3.45	254 10.00	—
300 12	323.9 12.750	500 3.45	254 10.00	UL FM VdS
350 14	355.6 14.000	300 2.07	280 11.02	—
350 14	377.0 14.84	300 2.07	279 10.96	—
400 16	406.4 16.000	300 2.07	305 12.00	—
400 16	426.0 16.77	300 2.07	285 11.22	—
450 18	457.2 18.000	300 2.07	342 13.46	—
450 18	480.0 18.90	300 2.07	335 13.19	—
500 20	508.0 20.000	300 2.07	381 15.00	—
600 24	609.6 24.000	300 2.07	432 17.01	—

130C

Reducing tee



Nominal Size mm/in	Pipe O.D mm/in	Working Pressure PSI/MPa	Dimensions					Certificate
			A	L mm/in	D mm/in	E mm/in	M mm/in	
100X80X25 4X3X1	114.3X88.9X33.7 4.5X3.5X1.327	300 2.07	1-11.5NPT Rp1-ISO7/1	160 6.3	102 4.02	102 4.02	60 2.36	UL FM
150X80X25 6X3X1	165.1X88.9X33.7 6.5X3.5X1.327	300 2.07	1-11.5NPT Rp1-ISO7/1	165 6.5	130 5.12	130 5.12	60 2.36	UL FM

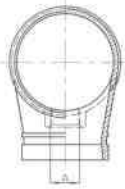
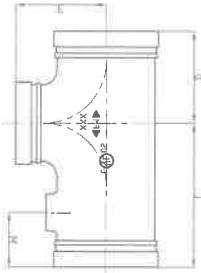

130D

Reducing tee



Nominal Size mm/in	Pipe O.D mm/in	Working Pressure PSI/MPa	Dimensions					Certificate
			A	L mm/in	D mm/in	E mm/in	M mm/in	
100X80X25 4X3X1	114.3X88.9X33.7 4.5X3.5X1.327	300 2.07	1-11.5NPT Rp1-ISO7/1	102 4.02	102 4.02	102 4.02	67 2.638	UL FM
150X80X25 6X3X1	165.1X88.9X33.7 6.5X3.5X1.327	300 2.07	1-11.5NPT Rp1-ISO7/1	130 5.12	130 5.12	130 5.12	91 3.58	UL FM

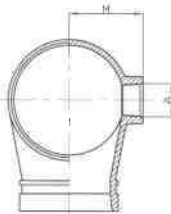
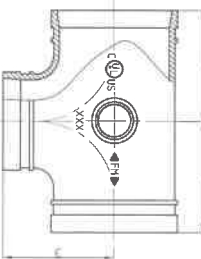

130S

Light-duty Tee

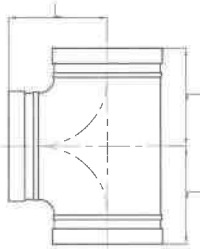

Nominal Size mm/in	Pipe O.D mm/in	Working Pressure PSI/MPa	Dimensions L mm/in	Certificate
50 2	60.3 2.375	300 2.07	70 2.75	UL FM VdS LPCB
65 2½	73.0 2.875	300 2.07	76 3.00	UL FM
65 2½	76.1 3.000	300 2.07	76 3.00	UL FM VdS LPCB
80 3	88.9 3.500	300 2.07	85.5 3.37	UL FM VdS LPCB
100 4	108.0 4.500	500 3.45	101 3.98	UL FM
100 4	114.3 4.500	300 2.07	101 3.98	UL FM VdS LPCB
125 5	139.7 5.500	300 2.07	124 4.88	UL FM VdS LPCB
150 6	159.0 6.500	300 2.07	140 5.50	UL FM
150 6	165.1 6.500	300 2.07	140 5.50	UL FM LPCB
150 6	168.3 6.625	300 2.07	140 5.50	UL FM VdS LPCB
200 8	216.3 8.625	300 2.07	175 6.89	UL FM
200 8	219.1 8.625	300 2.07	175 6.89	UL FM VdS LPCB

130R

Reducing Tee

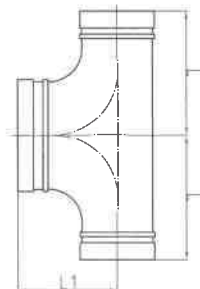

Nominal Size mm/in	Pipe O.D mm/in	Working Pressure PSI/MPa	Dimensions L mm/in	Dimensions L 1 mm/in	Certificate
65×65×80 2½×2½×3	76.1×76.1×88.9 3.000×3.000×3.500	500 3.45	108 4.25	95 3.74	—
65×65×100 2½×2½×4	76.1×76.1×114.3 3.000×3.000×4.500	500 3.45	127 5.00	102 4.02	—
80×80×100 3×3×4	88.9×88.9×114 3.500×3.500×4.500	500 3.45	127 5.00	102 4.02	—

130R

Reducing Tee

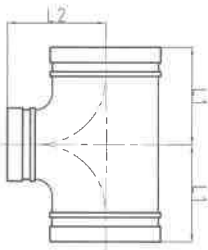

Nominal Size mm/in	Pipe O.D mm/in	Working Pressure PSI/MPa	Dimensions L 1 mm/in	Dimensions L 2 mm/in	Certificate
50×25 2×1	60.3×33.7 2.375×1.315	500 3.45	70 2.75	70 2.75	UL FM VdS LPCB
50×40 2×1½	60.3×48.3 2.375×1.900	500 3.45	70 2.75	70 2.75	UL FM VdS LPCB
65×40 2½×1½	73.0×48.3 2.875×1.900	500 3.45	76 3.00	76 3.00	UL FM
65×50 2½×2	73.0×60.3 2.875×2.375	500 3.45	69 2.72	76 3.00	UL FM
65×32 2½×1¼	76.1×42.4 3.000×1.660	500 3.45	76 3.00	76 3.00	UL FM
65×40 2½×1½	76.1×48.3 3.000×1.900	500 3.45	76 3.00	76 3.00	UL FM VdS LPCB
65×50 2½×2	76.1×60.3 3.000×2.375	500 3.45	69 2.72	76 3.00	UL FM VdS LPCB
80×32 3×1	88.9×33.7 3.500×1.315	500 3.45	108 4.25	108 4.25	UL FM VdS LPCB
80×32 3×1¼	88.9×42.4 3.500×1.660	500 3.45	85.5 3.37	85.5 3.37	UL FM
80×40 3×1½	88.9×48.3 3.500×1.900	500 3.45	85.5 3.37	85.5 3.37	UL FM VdS LPCB
80×50 3×2	88.9×60.3 3.500×2.375	500 3.45	85.5 3.37	85.5 3.37	UL FM VdS LPCB
80×65 3×2½	88.9×73.0 3.500×2.875	500 3.45	85.5 3.37	85.5 3.37	UL FM
80×65 3×2½	88.9×76.1 3.500×3.000	500 3.45	85.5 3.37	85.5 3.37	UL FM VdS LPCB
100×50 4×2	108.0×60.3 4.250×2.375	500 3.45	101 3.98	101 3.98	UL FM
100×80 4×3	108.0×88.9 4.250×3.500	500 3.45	101 3.98	101 3.98	UL FM
100×25 4×1	114.3×33.7 4.500×1.315	500 3.45	101 3.98	101 3.98	UL FM VdS LPCB
100×40 4×1½	114.3×48.3 4.500×1.900	500 3.45	101 3.98	101 3.98	UL FM VdS LPCB
100×50 4×2	114.3×60.3 4.500×2.375	500 3.45	101 3.98	101 3.98	UL FM VdS LPCB
100×65 4×2½	114.3×73.0 4.500×2.875	500 3.45	101 3.98	101 3.98	UL FM
100×65 4×2½	114.3×76.1 4.500×3.000	500 3.45	101 3.98	101 3.98	UL FM VdS LPCB
100×80 4×3	114.3×88.9 4.500×3.500	500 3.45	101 3.98	101 3.98	UL FM VdS LPCB
125×50 5×2	133.0×60.3 5.250×2.375	500 3.45	124 4.88	124 4.88	UL FM
125×65 5×2½	133.0×76.1 5.250×3.000	500 3.45	124 4.88	124 4.88	UL FM
125×100 5×4	133.0×108.0 5.250×4.250	500 3.45	124 4.88	124 4.88	UL FM
125×100 5×4	133.0×114.3 5.250×4.500	500 3.45	124 4.88	124 4.88	UL FM
125×40 5×1½	139.7×48.3 5.500×1.900	500 3.45	124 4.88	124 4.88	UL FM
125×50 5×2	139.7×60.3 5.500×2.375	500 3.45	124 4.88	124 4.88	UL FM
125×65 5×2½	139.7×76.1 5.500×3.000	500 3.45	124 4.88	124 4.88	UL FM
125×80 5×3	139.7×88.9 5.500×3.500	500 3.45	124 4.88	124 4.88	UL FM
125×100 5×4	139.7×114.3 5.500×4.500	500 3.45	124 4.88	124 4.88	UL FM VdS LPCB
125×50 5×2	141.3×60.3 5.563×2.375	500 3.45	124 4.88	124 4.88	UL FM
125×80 5×3	141.3×88.9 5.563×3.500	500 3.45	124 4.88	124 4.88	UL FM
125×100 5×4	141.3×114.3 5.563×4.500	500 3.45	124 4.88	124 4.88	UL FM
150×60 6×2	159.0×60.3 6.250×2.375	500 3.45	140 5.50	140 5.50	UL FM
150×65 6×2½	159.0×76.1 6.250×3.000	500 3.45	140 5.50	140 5.50	UL FM
150×80 6×3	159.0×88.9 6.250×3.500	500 3.45	140 5.50	140 5.50	UL FM
150×100 6×4	159.0×108.0 6.250×4.250	500 3.45	140 5.50	140 5.50	UL FM
150×100 6×4	159.0×114.3 6.250×4.500	500 3.45	140 5.50	140 5.50	UL FM

130R

Reducing Tee

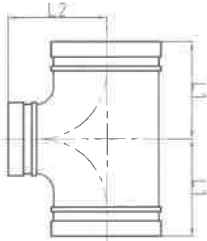

Nominal Size mm/in	Pipe O.D mm/in	Working Pressure PSI/MPa	Dimensions L 1 mm/in	Dimensions L 2 mm/in	Certificate
150 × 125 6 × 5	159.0 × 133.0 6.250 × 5.250	500 3.45	140 5.50	140 5.50	UL FM
150 × 90 6 × 2	165.1 × 60.3 6.500 × 2.375	300 2.07	140 5.50	140 5.50	UL FM
150 × 65 6 × 2½	165.1 × 76.1 6.500 × 3.000	300 2.07	140 5.50	140 5.50	UL FM
150 × 80 6 × 3	165.1 × 88.9 6.500 × 3.500	300 2.07	140 5.50	140 5.50	UL FM LPCB
150 × 100 6 × 4	165.1 × 114.3 6.500 × 4.500	300 2.07	140 5.50	140 5.50	UL FM LPCB
150 × 125 6 × 5	165.1 × 139.7 6.500 × 5.500	300 2.07	140 5.50	140 5.50	UL FM LPCB
165 × 133	165.1 × 133.0 6.500 × 5.250	300	140 5.50	140 5.50	UL
150 × 50 6 × 2	168.3 × 60.3 6.625 × 2.375	500 3.45	140 5.50	140 5.50	UL FM VdS LPCB
150 × 65 6 × 2½	168.3 × 73.0 6.625 × 2.875	500 3.45	140 5.50	140 5.50	UL FM
150 × 65 6 × 2½	168.3 × 76.1 6.625 × 3.000	500 3.45	140 5.50	140 5.50	UL FM VdS LPCB
150 × 80 6 × 3	168.3 × 88.9 6.625 × 3.500	500 3.45	140 5.50	140 5.50	UL FM VdS LPCB
150 × 100 6 × 4	168.3 × 114.3 6.625 × 4.500	500 3.45	140 5.50	140 5.50	UL FM VdS LPCB
150 × 125 6 × 5	168.3 × 139.7 6.625 × 5.500	300 2.07	140 5.50	140 5.50	UL FM VdS LPCB
150 × 125 6 × 5	168.3 × 141.3 6.625 × 5.563	300 2.07	140 5.50	140 5.50	UL FM
200 × 100 8 × 4	216.3 × 114.3 8.516 × 4.500	300 2.07	175 6.89	175 6.89	—
200 × 150 8 × 6	216.3 × 165.1 8.516 × 6.500	300 2.07	175 6.89	175 6.89	UL FM
200 × 50 8 × 2	219.1 × 60.3 8.625 × 2.375	500 3.45	175 6.89	175 6.89	UL FM VdS LPCB
200 × 65 8 × 2½	219.1 × 76.1 8.625 × 3.000	300 2.07	175 6.89	175 6.89	UL FM
200 × 80 8 × 3	219.1 × 88.9 8.625 × 3.500	500 3.45	175 6.89	175 6.89	UL FM VdS LPCB
200 × 100 8 × 4	219.1 × 108.0 8.625 × 4.250	500 3.45	175 6.89	175 6.89	UL FM
200 × 100 8 × 4	219.1 × 114.3 8.625 × 4.500	500 3.45	175 6.89	175 6.89	UL FM VdS LPCB
200 × 125 8 × 5	219.1 × 133.0 8.625 × 5.250	300 2.07	175 6.89	175 6.89	UL FM
200 × 125 8 × 5	219.1 × 139.7 8.625 × 5.500	300 2.07	175 6.89	175 6.89	UL FM
200 × 150 8 × 6	219.1 × 159.0 8.625 × 6.250	300 2.07	175 6.89	175 6.89	UL FM
200 × 150 8 × 6	219.1 × 165.1 8.625 × 6.500	300 2.07	175 6.89	175 6.89	UL FM
200 × 150 8 × 6	219.1 × 168.3 8.625 × 6.625	500 3.45	175 6.89	175 6.89	UL FM VdS LPCB
250 × 150 10 × 6	273.0 × 159.0 10.750 × 6.250	500 3.45	229 9.00	229 9.00	UL FM
250 × 150 10 × 6	273.0 × 165.1 10.750 × 6.500	300 2.07	229 9.00	229 9.00	UL FM
250 × 150 10 × 6	273.0 × 168.3 10.750 × 6.625	300 2.07	229 9.00	229 9.00	UL FM VdS
250 × 200 10 × 8	273.0 × 219.1 10.750 × 8.625	300 2.07	229 9.00	229 9.00	UL FM VdS
300 × 65 12 × 2½	323.9 × 73.0 12.750 × 2.875	300 2.07	254 10	254 10	—
300 × 80 12 × 3	323.9 × 88.9 12.750 × 3.500	300 2.07	254 10	254 10	—
300 × 150 12 × 6	323.9 × 165.1 12.750 × 6.500	300 2.07	254 10	254 10	UL FM
300 × 150 12 × 6	323.9 × 168.3 12.750 × 6.625	300 2.07	254 10	254 10	—
300 × 200 12 × 8	323.9 × 219.1 12.750 × 8.625	300 2.07	254 10	254 10	UL FM VdS
300 × 250 12 × 10	323.9 × 273.0 12.750 × 10.750	300 2.07	254 10	254 10	UL FM VdS
450 × 300 18 × 12	480.0 × 323.9 18.897 × 12.750	300 2.07	335 13.188	335 13.188	—
450 × 350 18 × 14	480.0 × 377.0 18.897 × 14.840	300 2.07	335 13.188	335 13.188	—

130R

Reducing Tee

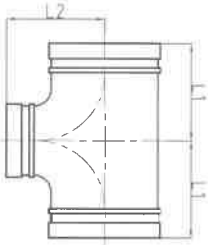

Nominal Size mm/in	Pipa O.D mm/in	Working Pressure PSI/MPa	Dimensions L1 mm/in	Dimensions L2 mm/in	Certificate
350×150 14×6	355.6×168.3 14.000×6.625	300 2.07	279 10.98	238 9.37	—
350×200 14×8	355.6×219.1 14.00×8.625	300 2.07	280 11.02	280 11.02	—
350×250 14×10	355.6×273.0 14.000×10.750	300 2.07	279 10.98	257 10.12	—
350×300 14×12	355.6×323.9 14.000×12.750	300 2.07	279 10.98	270 10.63	—
350×125 14×5	377.0×133.0 14.840×5.250	300 2.07	240 9.45	265 10.43	—
350×150 14×6	377.0×159.0 14.840×6.250	300 2.07	240 9.45	265 10.43	—
350×200 14×8	377.0×219.1 14.840×8.625	300 2.07	240 9.45	265 10.43	—
350×250 14×10	377.0×273.0 14.840×10.750	300 2.07	240 9.45	265 10.43	—
350×300 14×12	377.0×323.9 14.840×12.750	300 2.07	240 9.45	265 10.43	—
400×150 16×6	406.4×168.3 16.000×6.625	300 2.07	305 12.01	264 10.39	—
400×200 16×8	406.4×219.1 16.000×8.625	300 2.07	305 12.01	273 10.75	—
400×250 16×10	406.4×273.0 16.000×10.750	300 2.07	305 12.01	283 11.14	—
400×300 16×12	406.4×323.9 16.000×12.750	300 2.07	305 12.01	295 11.61	—
400×350 16×14	406.4×355.6 16.000×14.000	300 2.07	305 12.01	305 12.01	—
400×125 16×5	426.0×133.0 16.772×5.250	300 2.07	260 10.24	285 11.22	—
400×150 16×6	426.0×159.0 16.772×6.250	300 2.07	260 10.24	285 11.22	—
400×200 16×8	426.0×219.1 16.772×8.625	300 2.07	260 10.24	285 11.22	—
400×250 16×10	426.0×273.0 16.772×10.750	300 2.07	260 10.24	285 11.22	—
400×300 16×12	426.0×323.9 16.772×12.750	300 2.07	260 10.24	285 11.22	—
450×150 18×6	457.2×168.3 18.000×6.625	300 2.07	343 13.50	298 11.73	—
450×200 18×8	457.2×219.1 18.000×8.625	300 2.07	343 13.50	298 11.73	—
450×250 18×10	457.2×273.0 18.000×10.750	300 2.07	343 13.50	308 12.13	—
450×300 18×12	457.2×323.9 18.000×12.750	300 2.07	343 13.50	321 12.64	—
450×350 18×14	457.2×355.6 18.000×14.000	300 2.07	343 13.50	330 12.99	—
450×400 18×16	457.2×406.4 18.000×16.000	300 2.07	343 13.50	330 12.99	—
500×150 20×6	508.0×168.3 20.000×6.625	300 2.07	381 15.00	324 12.76	—
500×200 20×8	508.0×219.1 20.000×8.625	300 2.07	381 15.00	324 12.76	—
500×250 20×10	508.0×273.0 20.000×10.750	300 2.07	381 15.00	333 13.11	—
500×300 20×12	508.0×323.9 20.000×12.750	300 2.07	381 15.00	346 13.62	—
500×350 20×14	508.0×355.6 20.000×14.000	300 2.07	381 15.00	356 14.02	—
500×400 20×16	508.0×406.4 20.000×16.000	300 2.07	381 15.00	356 14.02	—
500×450 20×18	508.0×457.2 20.000×18.000	300 2.07	381 15.00	368 14.49	—
600×150 24×6	609.6×168.3 24.000×6.625	300 2.07	432 17.01	384 15.12	—
600×200 24×8	609.6×219.1 24.000×8.625	300 2.07	432 17.01	384 15.12	—
600×250 24×10	609.6×273.0 24.000×10.750	300 2.07	432 17.01	384 15.12	—
600×300 24×12	609.6×323.9 24.000×12.750	300 2.07	432 17.01	397 15.63	—
600×350 24×14	609.6×355.6 24.000×14.000	300 2.07	432 17.01	406 15.98	—
600×400 24×16	609.6×406.4 24.000×16.000	300 2.07	432 17.01	406 15.98	—
600×450 24×18	609.6×457.2 24.000×18.000	300 2.07	432 17.01	419 16.50	—
600×500 24×20	609.6×508.0 24.000×20.000	300 2.07	432 17.01	432 17.01	—

Segmental sizes are made of carbon steel pipe or fabricated from wrought carbon steel. Contact manufacturer for details.

131R

Reducing Tee
with Female Thread

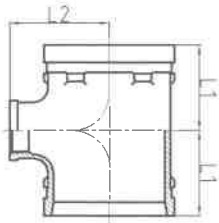

Nominal Size mm/in	Pipe O.D mm/in	Working Pressure PSI/MPa	Dimensions L 1 mm/in	Dimensions L 2 mm/in	Certificate
100×25 4×1	114.3×33.7 4.500×1.315	300 2.07	76 2.99	88 3.47	UL FM
100×32 4×1¼	114.3×42.4 4.500×1.680	300 2.07	76 2.99	88 3.47	UL FM
100×40 4×1½	114.3×48.3 4.500×1.900	300 2.07	85 3.35	91 3.58	UL FM
100×50 4×2	108.0×60.3 4.250×2.375	300 2.07	85 3.35	91 3.58	UL FM
100×50 4×2	114.3×60.3 4.500×2.375	300 2.07	85 3.35	91 3.58	UL FM
125×50 5×2	133.0×60.3 5.250×2.375	300 2.07	86 3.39	106 4.17	UL FM
125×65 5×2½	133.0×76.1 5.250×3.000	300 2.07	102 4.02	111 4.37	UL FM
125×80 5×3	133.0×88.9 5.250×3.500	300 2.07	102 4.02	111 4.37	UL FM
125×25 5×1	139.7×33.7 5.500×1.315	300 2.07	78 3.07	103 4.06	UL FM
125×32 5×1¼	139.7×42.4 5.500×1.680	300 2.07	78 3.07	103 4.06	UL FM
125×40 5×1½	139.7×48.3 5.500×1.900	300 2.07	86 3.39	106 4.17	UL FM
125×50 5×2	139.7×60.3 5.500×2.375	300 2.07	86 3.39	106 4.17	UL FM
125×65 5×2½	139.7×76.1 5.500×3.000	300 2.07	102 4.02	111 4.37	UL FM
125×80 5×3	139.7×88.9 5.500×3.500	300 2.07	102 4.02	111 4.37	UL FM
150×60 6×2	159.0×60.3 6.250×2.375	300 2.07	92 3.62	124 4.88	UL FM
150×65 6×2½	159.0×76.1 6.250×3.000	300 2.07	107 4.21	129 5.08	UL FM
150×80 6×3	159.0×88.9 6.250×3.500	300 2.07	107 4.21	129 5.08	UL FM
150×25 6×1	165.1×33.7 6.500×1.315	300 2.07	83 3.27	121 4.76	UL FM
150×32 6×1¼	165.1×42.4 6.500×1.680	300 2.07	83 3.27	121 4.76	UL FM
150×40 6×1½	165.1×48.3 6.500×1.900	300 2.07	92 3.62	124 4.88	UL FM
150×50 6×2	165.1×60.3 6.500×2.375	300 2.07	92 3.62	124 4.88	UL FM
150×65 6×2½	165.1×76.1 6.500×3.000	300 2.07	107 4.21	129 5.08	UL FM
150×80 6×3	165.1×88.9 6.500×3.500	300 2.07	107 4.21	129 5.08	UL FM
150×50 6×2	168.3×60.3 6.625×2.375	300 2.07	92 3.62	124 4.88	UL FM
150×65 6×2½	168.3×76.1 6.625×3.000	300 2.07	107 4.21	129 5.08	UL FM
150×80 6×3	168.3×88.9 6.625×3.500	300 2.07	107 4.21	129 5.08	—

180

Cross

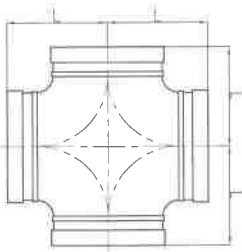

Nominal Size mm/in	Pipe O.D. mm/in	Working Pressure PSI/MPa	Dimensions L mm/in	Certificate
32 1¼	42.4 1.660	500 3.45	70 2.75	UL FM VdS LPCB
40 1½	48.3 1.900	500 3.45	70 2.75	UL FM VdS LPCB
50 2	60.3 2.375	500 3.45	70 2.75	UL FM VdS LPCB
65 2½	73.0 2.875	500 3.45	76 3.00	UL FM
65 2½	76.1 3.000	500 3.45	76 3.00	UL FM VdS LPCB
80 3	88.9 3.500	500 3.45	85.5 3.37	UL FM VdS LPCB
100 4	108.0 4.250	500 3.45	101 3.98	UL FM
100 4	114.3 4.500	500 3.45	101 3.98	UL FM VdS LPCB
125 5	139.7 5.500	500 3.45	124 4.88	UL FM VdS LPCB
125 5	141.3 5.563	500 3.45	124 4.88	UL FM
150 6	159.0 6.250	500 3.45	140 5.50	UL FM
150 6	165.1 6.500	500 3.45	140 5.50	UL FM LPCB
150 6	168.3 6.625	500 3.45	140 5.50	UL FM VdS LPCB
200 8	219.1 8.625	500 3.45	175 6.89	UL FM VdS LPCB
250 10	273.0 10.750	500 3.45	229 9.00	UL FM VdS
300 12	323.9 12.750	500 3.45	254 10.00	UL FM VdS
350 14	355.6 14.000	300 2.07	279 10.98	—
350 14	377.0 14.84	300 2.07	279 10.98	—
400 16	406.4 16.000	300 2.07	305 12.01	—
450 18	457.2 18.000	300 2.07	343 13.5	—
500 20	508.0 20.000	300 2.07	381 15.00	—
600 24	609.6 24.000	300 2.07	432 17.01	—

Segmental sizes are made of carbon steel pipe or fabricated from wrought carbon steel. Contact manufacturer for details.

180R

Reducing Cross

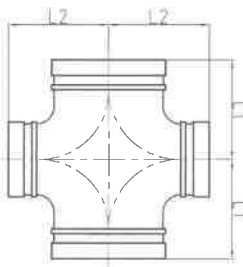

Nominal Size mm/in	Pipe O.D mm/in	Working Pressure PSI/MPa	Dimensions L 1 mm/in	Dimensions L 2 mm/in	Certificate
65×50 2½×2	76.1×60.3 3.000×2.375	500 3.45	76 3.00	76 3.00	—
80×50 3×2	88.9×60.3 3.500×2.375	500 3.45	85.5 3.37	85.5 3.37	UL FM
100×50 4×2	114.3×60.3 4.500×2.375	500 3.45	101 3.98	101 3.98	UL FM
100×80 4×3	114.3×88.9 4.500×3.500	500 3.45	101 3.98	101 3.98	UL FM
125×100 5×4	139.7×114.3 5.500×4.500	500 3.45	124 4.88	124 4.88	UL FM
159×108	159.0×108.0 6.250×4.250	500 3.45	124 4.88	124 5.50	UL FM
150×50 6×2	165.1×60.3 6.500×2.375	500 3.45	140 5.50	140 5.50	UL FM
150×65 6×2½	165.1×76.1 6.500×3.000	500 3.45	140 5.50	140 5.50	UL FM
150×80 6×3	165.1×88.9 6.500×3.500	500 3.45	140 5.50	140 5.50	UL FM
150×100 6×4	165.1×114.3 6.500×4.500	500 3.45	140 5.50	140 5.50	UL FM
150×50 6×2	168×60.3 6.625×2.375	500 3.45	140 5.50	140 5.50	UL FM
200×50 8×2	219.1×60.3 8.625×2.375	500 3.45	197 7.75	197 7.75	UL FM
200×100 8×4	219.1×114.3 8.625×4.500	500 3.45	175 6.89	175 6.89	UL FM
200×125 8×5	219.1×139.7 8.625×5.500	300 2.07	175 6.89	175 6.89	UL FM
200×150 8×6	219.1×159.0 8.625×6.250	300 2.07	175 6.89	175 6.89	UL FM
200×150 8×6	219.1×165.1 8.625×6.500	300 2.07	175 6.89	175 6.89	UL FM

181

Reducing Cross with Female Thread

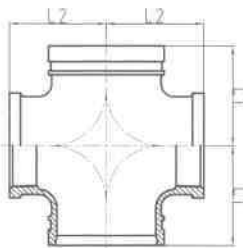

Nominal Size mm/in	Pipe O.D mm/in	Working Pressure PSI/MPa	Dimensions L 1 mm/in	Dimensions L 2 mm/in	Certificate
65×50 2½×2	76.1×60.3 3.000×2.375	300 2.07	76 3.00	76 3.00	—
80×32 3×1¼	88.9×42.4 3.500×1.660	300 2.07	108 4.25	108 4.25	—
80×40 3×1½	88.9×48.3 3.500×1.900	300 2.07	85.5 3.37	85.5 3.37	—
80×50 3×2	88.9×60.3 3.500×2.375	300 2.07	85.5 3.37	85.5 3.37	—
100×25 4×1	114.3×33.7 4.500×1.315	300 2.07	76 2.99	88 3.47	UL FM
100×32 4×1¼	114.3×42.4 4.500×1.660	300 2.07	76 2.99	88 3.47	UL FM
100×40 4×1½	114.3×48.3 4.500×1.900	300 2.07	85 3.35	91 3.58	UL FM
100×50 4×2	114.3×60.3 4.500×2.375	300 2.07	85 3.35	91 3.58	UL FM
100×65 4×2½	114.3×76.1 4.500×3.000	300 2.07	101 3.98	96 3.78	—
100×80 4×3	114.3×88.9 4.500×3.500	300 2.07	101 3.98	96 3.78	—
150×32 6×1¼	165.1×42.4 6.500×1.660	300 2.07	92 3.62	124 4.88	—
150×40 6×1½	165.1×48.3 6.500×1.900	300 2.07	92 3.62	124 4.88	—
150×50 6×2	165.1×60.3 6.500×2.375	300 2.07	92 3.62	124 4.88	UL FM
150×65 6×2½	165.1×76.1 6.500×3.000	300 2.07	140 5.50	140 5.50	—
150×80 6×3	165.1×88.9 6.500×3.500	300 2.07	140 5.50	140 5.50	—
200×80 8×3	219.1×88.9 8.625×3.500	300 2.07	175 6.89	175 6.89	—

3L

U-Bolt Mechanical Tee

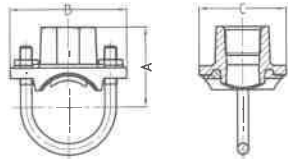

Nominal Size mm/in	Hole Dia mm/in +1.6,0/+0.063,0	Working Pressure PSI/MPa	Dimensions			U Bolt Size mm/in	Certificate
			A mm/in	B mm/in	C mm/in		
32X15 1½X1½	30 1.18	300 2.07	54.4 2.14	88.9 3.50	57.2 2.25	3/8X73 M10X73	UL FM VdS
32X20 1½X3/4	30 1.18	300 2.07	54.4 2.14	88.9 3.50	57.2 2.25	3/8X73 M10X73	UL FM VdS
32X25 1½X1	30 1.18	300 2.07	57.7 2.27	88.9 3.50	57.2 2.25	3/8X73 M10X73	UL FM VdS
40X15 1½X1/2	30 1.18	300 2.07	57.7 2.27	88.9 3.50	57.2 2.25	3/8X73 M10X73	UL FM VdS
40X20 1½X3/4	30 1.18	300 2.07	57.7 2.27	88.9 3.50	57.2 2.25	3/8X73 M10X73	UL FM VdS
40X25 1½X1	30 1.18	300 2.07	60.8 2.39	88.9 3.50	57.2 2.25	3/8X73 M10X73	UL FM VdS
50X15 2X1/2	30 1.18	300 2.07	63.3 2.49	95.3 3.75	57.2 2.25	3/8X90 M10X90	UL FM VdS
50X20 2X3/4	30 1.18	300 2.07	63.3 2.49	95.3 3.75	57.2 2.25	3/8X90 M10X90	UL FM VdS
50X25 2X1	30 1.18	300 2.07	66.6 2.62	95.3 3.75	57.2 2.25	3/8X90 M10X90	UL FM VdS
50X32 2X1¼	45 1.75	300 2.07	66.6 2.62	4.72 120	3.00 76	1/2X52	—
65X15 2½X1/2	30 1.18	300 2.07	69.9 2.75	108.0 4.25	57.2 2.250	3/8X105 M10X105	UL FM
65X20 2½X3/4	30 1.18	300 2.07	69.9 2.75	108.0 4.25	57.2 2.250	3/8X105 M10X105	UL FM
65X25 2½X1	30 1.18	300 2.07	73.2 2.88	108.0 4.25	57.2 2.25	3/8X105 M10X105	UL FM
65X15 76.1X1/2	30 1.18	300 2.07	69.9 2.75	108.0 4.25	57.2 2.250	3/8X105 M10X105	UL FM VdS
65X20 76.1X3/4	30 1.18	300 2.07	69.9 2.75	108.0 4.25	57.2 2.250	3/8X105 M10X105	UL FM VdS
65X25 76.1X1	30 1.18	300 2.07	73.2 2.88	108.0 4.25	57.2 2.25	3/8X105 M10X105	UL FM VdS
80X25 88.9X1	38 1.5	300 2.07	79 3.11	145 5.70	73 2.87	1/2X58	UL FM VdS
100X25 4X1	30 1.18	300 2.07	89 3.50	185 7.28	72 2.83	1/2X70	FM
100X32 4X1¼	51 2	300 2.07	95 3.74	185 7.28	85 3.35	1/2X70	FM
100X40 4X1½	51 2	300 2.07	95 3.74	185 7.28	85 3.35	1/2X70	FM
150X25 6X1	38 1.5	300 2.07	124 4.88	254 10.0	75 2.95	5/8X102	FM

3G

Mechanical Tee Grooved Outlet

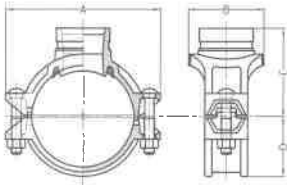

Nominal Size mm/in	Pipe O.D mm/in	Working Pressure PSI/MPa	Hole Dia mm/in +1.6,0/+0.063,0	Dimensions				Bolt Size mm/in	Certificate
				A mm/in	B mm/in	C mm/in	D mm/in		
50×32 2×1¼	60.3×42.4 2.375×1.660	300 2.07	45 1.75	116 4.57	76 2.99	69.5 2.74	39 1.54	3/8×55 M10X57	UL FM VdS
50×40 2×1½	60.3×48.3 2.375×1.900	300 2.07	45 1.75	116 4.57	76 2.99	69.5 2.74	39 1.54	3/8×55 M10X57	UL FM VdS
65×25 2½×1	73.0×33.7 2.875×1.315	300 2.07	38 1.50	137 5.39	71 2.80	78 3.07	49 1.93	1/2×70 M12X70	—
65×32 2½×1¼	73.0×42.4 2.875×1.660	300 2.07	51 2.00	137 5.39	84.5 3.33	78 3.07	49 1.93	1/2×70 M12X70	UL FM
65×40 2½×1½	73.0×48.3 2.875×1.900	300 2.07	51 2.00	137 5.39	84.5 3.33	78 3.07	49 1.93	1/2×70 M12X70	UL FM
65×25 76.1×1	76.1×33.7 3.000×1.315	300 2.07	38 1.50	137 5.39	71 2.80	78 3.07	49.5 1.95	1/2×70 M12X70	UL FM VdS
65×32 76.1×1¼	76.1×42.4 3.000×1.660	300 2.07	51 2.00	137 5.39	84.5 3.33	78 3.07	49.5 1.95	1/2×70 M12X70	UL FM VdS
65×40 76.1×1½	76.1×48.3 3.000×1.900	300 2.07	51 2.00	137 5.39	84.5 3.33	78 3.07	49.5 1.95	1/2×70 M12X70	UL FM VdS
80×25 3×1	88.9×33.7 3.500×1.315	300 2.07	38 1.50	152 5.98	72.5 2.85	84.5 3.33	56.5 2.22	1/2×75 M12X75	UL FM VdS
80×32 3×1¼	88.9×42.4 3.500×1.660	300 2.07	51 2.00	152 5.98	85.5 3.37	84.5 3.33	56.5 2.22	1/2×75 M12X75	UL FM VdS
80×40 3×1½	88.9×48.3 3.500×1.900	300 2.07	51 2.00	152 5.98	85.5 3.37	84.5 3.33	56.5 2.22	1/2×75 M12X75	UL FM VdS
80×50 3×2	88.9×60.3 3.500×2.375	300 2.07	64 2.50	152 5.98	98 3.86	84.5 3.33	56.5 2.22	1/2×75 M12X75	UL FM VdS
100×25 4×1	114.3×33.7 4.500×1.315	300 2.07	38 1.50	188 7.40	188 3.09	102 4.02	70 2.76	1/2×75 M12X75	UL FM VdS
100×32 4×1¼	114.3×42.4 4.500×1.660	300 2.07	51 2.00	188 7.40	89 3.50	102 4.02	70 2.76	1/2×75 M12X75	UL FM VdS
100×40 4×1½	114.3×48.3 4.500×1.900	300 2.07	51 2.00	188 7.40	89 3.50	102 4.02	70 2.76	1/2×75 M12X75	UL FM VdS
100×50 4×2	114.3×60.3 4.500×2.375	300 2.07	64 2.5	188 7.40	104.5 4.11	102 4.02	70 2.76	1/2×75 M12X75	UL FM VdS
100×65 4×2½	114.3×73.0 4.500×2.875	300 2.07	70 2.75	188 7.40	104.5 4.11	102 4.02	70 2.76	1/2×75 M12X75	UL FM
100×65 4×76.1	114.3×76.1 4.500×3.000	300 2.07	70 2.75	188 7.40	104.5 4.11	102 4.02	70 2.76	1/2×75 M12X75	VdS LPCB
100×80 4×3	114.3×88.9 4.500×3.500	300 2.07	89 3.50	188 7.40	128 5.03	102 4.02	70 2.76	1/2×75 M12X75	UL FM VdS LPCB
125×32 139.7×1¼	139.7×42.4 5.500×1.660	300 2.07	51 2.00	221.5 8.72	95 3.74	118 4.65	84 3.31	5/8×85 M16X85	UL FM
125×40 139.7×1½	139.7×48.3 5.500×1.900	300 2.07	51 2.00	221.5 8.72	95 3.74	118 4.65	84 3.31	5/8×85 M16X85	UL FM
125×50 139.7×2	139.7×60.3 5.500×2.375	300 2.07	64 2.5	221.5 8.72	112.5 4.43	118 4.65	84 3.31	5/8×85 M16X85	UL FM VdS
125×65 139.7×76.1	139.7×76.1 5.500×3.000	300 2.07	70 2.75	221.5 8.72	112.5 4.43	118 4.65	84 3.31	5/8×85 M16X85	UL FM VdS LPCB
125×80 139.7×3	139.7×88.9 5.500×3.500	300 2.07	89 3.50	221.5 8.72	132 5.20	118 4.65	84 3.31	5/8×85 M16X85	UL FM VdS LPCB
125×100 139.7×4	139.7×114.3 5.500×4.500	300 2.07	114 4.50	221.5 8.72	160 6.30	125 4.92	84 3.31	5/8×85 M16X85	UL FM VdS LPCB
150×50 159.0×2	159.1×60.3 6.250×2.375	300 2.07	64 2.5	244 9.60	112.5 4.43	125 4.92	94 3.70	5/8×105 M16X108	—
150×100 159.0×108.0	159.1×108.0 6.250×4.250	300 2.07	114 4.50	244 9.60	154 6.06	133 5.24	94 3.70	5/8×105 M16X108	UL FM
150×100 159.0×4	159.1×114.3 6.250×4.500	300 2.07	114 4.50	244 9.60	159 6.26	125 4.92	94 3.70	5/8×105 M16X108	UL FM
150×50 165.1×2	165.1×60.3 6.500×2.375	300 2.07	64 2.5	244 9.60	112.5 4.43	127 5.00	97.5 3.84	5/8×105 M16X108	UL FM
150×65 165.1×76.1	165.1×76.1 6.500×3.000	300 2.07	70 2.75	244 9.60	112.5 4.43	130 5.12	97.5 3.84	5/8×105 M16X108	UL FM LPCB
150×80 6½O.D×3	165.1×88.9 6.500×3.500	300 2.07	89 3.50	244 9.60	132 5.20	130 5.12	97.5 3.84	5/8×105 M16X108	UL FM LPCB
150×100 6½O.D×4	165.1×114.3 6.500×4.500	300 2.07	114 4.50	244 9.60	154 6.06	135 5.32	97.5 3.84	5/8×105 M16X108	UL FM LPCB
150×40 6×1½	168.3×48.3 6.500×1.900	300 2.07	51 2.00	247 9.72	95 3.74	128 5.04	98.5 3.88	5/8×105 M16X108	UL FM VdS
150×50 6×2	168.3×60.3 6.625×2.375	300 2.07	64 2.5	247 9.72	114 4.49	134 5.28	98.5 3.88	5/8×105 M16X108	UL FM VdS

3G

Mechanical Tee Grooved Outlet

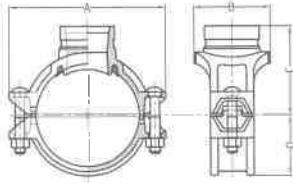

Nominal Size mm/in	Pipe O.D mm/in	Working Pressure PSI/MPa	Hole Dia mm/in +1.6,0/+0.063,0	Dimensions				Bolt Size mm/in	Certificate
				A mm/in	B mm/in	C mm/in	D mm/in		
150×65 6×2½	168.3×73.0 6.625×2.875	300 2.07	70 2.75	247 9.72	112.5 4.43	135 5.32	98.5 3.88	5/8×105 M16X108	UL FM
150×65 6×2½	168.3×76.1 6.625×3.000	300 2.07	70 2.75	247 9.72	112.5 4.43	135 5.32	98.5 3.88	5/8×105 M16X108	Vds LPCB
150×80 6×3	168.3×88.9 6.625×3.500	300 2.07	89 3.50	247 9.72	132 5.20	136.5 5.37	98.5 3.88	5/8×105 M16X108	UL FM Vds LPCB
150×100 6×4	168.3×114.3 6.625×4.500	300 2.07	114 4.50	247 9.72	160 6.30	138 5.43	98.5 3.88	5/8×105 M16X108	UL FM Vds LPCB
200×50 8×2	219.1×60.3 8.625×2.375	300 2.07	64 2.5	320 12.60	118 4.65	158 6.22	125 4.92	3/4×115 M20X115	UL FM Vds
200×65 8×2½	216.3×76.1 8.516×3.000	300 2.07	70 2.75	315 12.40	117 4.61	157 6.18	122 4.80	3/4×115 M20X115	—
200×65 8×2½	219.1×73.0 8.625×2.875	300 2.07	70 2.75	320 12.60	118 4.65	158 6.22	125 4.92	3/4×115 M20X115	UL FM Vds LPCB
200×65 8×2½	219.1×76.1 8.625×3.000	300 2.07	70 2.75	320 12.60	118 4.65	158 6.22	125 4.92	3/4×115 M20X115	UL FM Vds LPCB
200×80 8×3	219.1×88.9 8.625×3.500	300 2.07	89 3.50	320 12.60	136.5 5.37	161 6.34	125 4.92	3/4×115 M20X115	UL FM Vds LPCB
200×100 8×4	219.1×108.0 8.625×4.250	300 2.07	114 4.50	320 12.60	162 6.38	161 6.34	125 4.92	3/4×115 M20X115	UL FM
200×100 8×4	219.1×114.3 8.625×4.500	300 2.07	114 4.50	320 12.60	162 6.38	161 6.34	125 4.92	3/4×115 M20X115	UL FM Vds LPCB
250×65 10×2½	273.0×76.1 10.75×3.000	300 2.07	70 2.75	376 14.80	118 4.65	189 7.44	155 6.10	3/4×120 M20X115	—
250×80 10×3	273.0×88.9 10.75×3.500	300 2.07	89 3.50	376 14.80	136.5 5.37	189 7.44	155 6.10	3/4×120 M20X115	—
250×100 10×4	273.0×108 10.75×4.250	300 2.07	114 4.50	376 14.80	164 6.46	189 7.44	155 6.10	3/4×120 M20X115	UL FM
250×100 10×4	273.0×114.3 10.75×4.500	300 2.07	114 4.50	376 14.80	164 6.46	189 7.44	155 6.10	3/4×120 M20X115	UL FM Vds

3GS

Light-duty Mechanical Tee Grooved Outlet

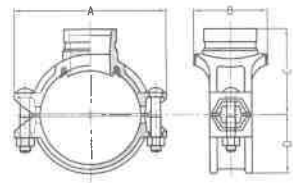

Nominal Size mm/in	Pipe O.D mm/in	Working Pressure PSI/MPa	Hole Dia mm/in +1.6,0/+0.063,0	Dimensions				Bolt Size mm/in	Certificate
				A mm/in	B mm/in	C mm/in	D mm/in		
80×25 3×1	88.9×33.7 3.500×1.315	365 2.52	38 1.50	150 5.91	71.0 2.80	84 3.31	55.5 2.19	1/2×75 M12X76	UL FM
80×32 3×1¼	88.9×42.4 3.500×1.660	365 2.52	51 2.00	150 5.91	84.5 3.33	84 3.31	55.5 2.19	1/2×75 M12X76	UL FM
80×40 3×1½	88.9×48.3 3.500×1.900	365 2.52	51 2.00	150 5.91	84.5 3.33	84 3.31	55.5 2.19	1/2×75 M12X76	UL FM
80×50 3×2	88.9×60.3 3.500×2.375	365 2.52	64 2.50	150 5.91	98 3.86	84 3.31	55.5 2.19	1/2×75 M12X76	UL FM
100×25 4×1	114.3×33.7 4.500×1.315	300 2.07	38 1.50	178 7.01	77.5 3.05	98 3.86	67.5 2.66	1/2×75 M12X76	UL FM
100×40 4×1½	114.3×48.3 4.500×1.900	300 2.07	51 2.00	178 7.01	88 3.46	98 3.86	67.5 2.66	1/2×75 M12X76	UL FM
100×50 4×2	114.3×60.3 4.500×2.375	300 2.07	64 2.50	178 7.01	103.5 4.07	98 3.86	67.5 2.66	1/2×75 M12X76	UL FM
100×65 4×2½	114.3×73.0 4.500×2.875	300 2.07	70 2.75	178 7.01	103.5 4.07	98 3.86	67.5 2.66	1/2×75 M12X76	UL FM
100×65 4×2½	114.3×76.1 4.500×3.000	300 2.07	70 2.75	178 7.01	103.5 4.07	98 3.86	67.5 2.66	1/2×75 M12X76	UL FM
100×80 4×3	114.3×88.9 4.500×3.500	300 2.07	89 3.50	178 7.01	124 4.88	98 3.86	67.5 2.66	1/2×75 M12X76	UL FM

3GS

Light-duty
Mechanical Tee
Grooved Outlet

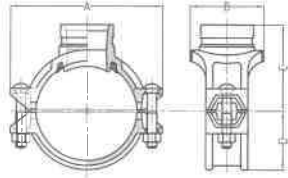

Nominal Size mm/in	Pipe O.D mm/in	Working Pressure PSI/MPa	Hole Dia mm/in +1.6,0/+0.063,0	Dimensions				Bolt Size mm/in	Certificate
				A mm/in	B mm/in	C mm/in	D mm/in		
125×80 133.0×3	133.0×88.9 5.250×3.500	300 2.07	89 3.50	203 7.99	132 5.12	110 4.33	77.5 3.05	5/8×85 M16X85	UL FM
125×32 139.7×11/4	139.7×42.4 5.500×1.660	300 2.07	51 2.00	210 8.27	91 3.58	113 4.45	82 3.23	5/8×85 M16X85	UL FM
125×40 139.7×11/2	139.7×48.3 5.500×1.900	300 2.07	51 2.00	210 8.27	91 3.58	113 4.45	82 3.23	5/8×85 M16X85	UL FM
125×50 139.7×2	139.7×60.3 5.500×2.375	300 2.07	64 2.50	210 8.27	110 4.33	113 4.45	82 3.23	5/8×85 M16X85	UL FM
125×65 139.7×76.1	139.7×76.1 5.500×3.000	300 2.07	70 2.75	210 8.27	110 4.33	113 4.45	82 3.23	5/8×85 M16X85	UL FM
125×80 139.7×3	139.7×88.9 5.500×3.500	300 2.07	89 3.50	210 8.27	130 5.12	113 4.45	82 3.23	5/8×85 M16X85	UL FM
125×6 139.7×4	139.7×114.3 5.500×4.500	175 1.21	114 4.50	210 8.27	153 6.02	115 4.52	82 3.23	5/8×85 M16X85	UL FM
150×65 159.0×76.1	159.0×76.1 6.250×3.000	300 2.07	70 2.75	227 8.94	110 4.33	122.5 4.83	91 3.58	5/8×105 M16X108	UL FM
150×80 159.0×88.9	159.0×88.9 6.250×3.500	300 2.07	89 3.50	227 8.94	130 5.11	122.5 4.83	91 3.58	5/8×105 M16X108	UL FM
150×100 159.0×108.0	159.0×108.0 6.250×4.250	300 2.07	114 4.50	227 8.94	155 6.10	122.5 4.83	91 3.58	5/8×105 M16X108	UL FM
150×100 159.0×4	159.0×114.3 6.250×4.500	300 2.07	114 4.50	227 8.94	155 6.10	122.5 4.83	91 3.58	5/8×105 M16X108	UL FM
150×32 165.1×11/4	165.1×42.4 6.500×1.900	300 2.07	51 2.00	235 9.25	92.5 3.64	124.5 4.90	94.5 3.72	5/8×105 M16X108	UL FM
150×50 165.1×2	165.1×60.3 6.500×2.375	300 2.07	64 2.50	235 9.25	110 4.33	124.5 4.90	94.5 3.72	5/8×105 M16X108	UL FM
150×65 165.1×76.1	165.1×76.1 6.500×3.000	300 2.07	70 2.75	235 9.25	110 4.33	124.5 4.90	94.5 3.72	5/8×105 M16X108	UL FM
150×80 165.1×3	165.1×88.9 6.500×3.500	300 2.07	89 3.50	235 9.25	130 5.12	124.5 4.90	94.5 3.72	5/8×105 M16X108	UL FM
150×100 165.1×4	165.1×108 6.500×4.250	300 2.07	114 4.50	235 9.25	155 6.10	126 4.96	94.5 3.72	5/8×105 M16X108	—
150×100 165.1×4	165.1×114.3 6.500×4.500	300 2.07	114 4.50	235 9.25	155 6.10	126 4.96	94.5 3.72	5/8×105 M16X108	UL FM
150×32 6×1/4	168.3×42.4 6.500×1.660	300 2.07	51 2.00	240 9.45	92.5 3.64	126 4.96	96.5 3.80	5/8×105 M16X108	UL FM
150×40 6×1/2	168.3×48.3 6.500×1.900	300 2.07	51 2.00	240 9.45	92.5 3.64	126 4.96	96.5 3.80	5/8×105 M16X108	UL FM
150×50 6×2	168.3×60.3 6.625×2.375	300 2.07	64 2.50	240 9.45	110 4.33	126 4.96	96.5 3.80	5/8×105 M16X108	UL FM
150×65 6×2 1/2	168.3×73.0 6.625×2.875	300 2.07	70 2.75	240 9.45	110 4.33	126 4.96	96.5 3.80	5/8×105 M16X108	UL FM
150×65 6×76.1	168.3×76.1 6.625×3	300 2.07	70 2.75	240 9.45	110 4.33	126 4.96	96.5 3.80	5/8×105 M16X108	UL FM
150×80 6×3	168.3×88.9 6.625×3.500	300 2.07	89 3.50	240 9.45	130 5.12	126 4.96	96.5 3.80	5/8×105 M16X108	UL FM
150×100 6×4	168.3×114.3 6.625×4.500	300 2.07	114 4.50	240 9.45	155 6.10	128 5.04	96.5 3.80	5/8×105 M16X108	UL FM
200×50 8×2	219.1×60.3 8.625×2.375	300 2.07	64 2.50	300 11.81	117 4.60	155 6.10	123 4.84	5/8×105 M16X108	UL FM
200×65 8×2 1/2	219.1×73 8.625×2.875	300 2.07	70 2.75	300 11.81	117 4.60	155 6.10	123 4.84	5/8×105 M16X108	UL FM
200×65 8×76.1	219.1×76.1 8.625×3.000	300 2.07	70 2.75	300 11.81	117 4.60	155 6.10	123 4.84	5/8×105 M16X108	UL FM
200×80 8×3	219.1×88.9 8.625×3.500	300 2.07	89 3.50	300 11.81	135.5 5.33	165 6.10	123 4.84	5/8×105 M16X108	UL FM
200×100 8×4	219.1×114.3 8.625×4.500	300 2.07	114 4.50	300 11.81	164 6.46	160 6.30	123 4.84	5/8×105 M16X108	UL FM

3J

Mechanical Tee Threaded Outlet

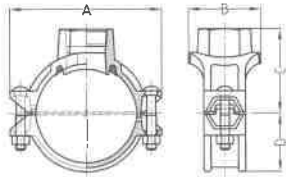

Nominal Size mm/in	Pipe O.D. mm/in	Working Pressure PSI/MPa	Hole Dia. mm/in +1.6,0/+0.063,0	Dimensions				Bolt Size mm/in	Certificate
				A mm/in	B mm/in	C mm/in	D mm/in		
25X10 1X3/8	33.7X17.2 1.315X0.677	300 2.07	23.5 0.92	86 3.38	46 1.81	26 1.02	24.5 0.96	M8X30	—
25X15 1X1/2	33.7X21.3 1.315X0.825	300 2.07	23.5 0.92	86 3.38	46 1.81	26 1.02	24.5 0.96	M8X30	Vds
25X20 1X3/4	33.7X26.9 1.315X1.050	300 2.07	23.5 0.92	86 3.38	52 2.05	41 1.61	24.5 0.96	M8X30	Vds
25X25 1X1	33.7X33.7 1.315X1.315	300 2.07	23.5 0.92	86 3.38	57 2.24	45 1.77	24.5 0.96	M8X30	Vds
32X10 1 1/4X3/8	42.4X17.2 1.660X0.677	300 2.07	30 1.18	95.5 3.76	53 2.09	32 1.26	29 1.14	M10X35	—
32X15 1 1/4X1/2	42.4X21.3 1.660X0.825	300 2.07	30 1.18	95.5 3.76	57 2.24	32 1.26	29 1.14	M10X35	Vds
32X20 1 1/4X3/4	42.4X26.9 1.660X1.050	300 2.07	30 1.18	95.5 3.76	57 2.24	44 1.73	29 1.14	M10X35	Vds
32X25 1 1/4X1	42.4X33.7 1.660X1.315	300 2.07	30 1.18	95.5 3.76	57 2.24	53 2.09	29 1.14	M10X35	Vds
40X10 1 1/2X3/8	48.3X17.2 1.900X0.677	300 2.07	30 1.18	101.5 3.99	53 2.09	34 1.34	32.5 1.28	M10X35	—
40X15 1 1/2X1/2	48.3X21.3 1.900X0.825	300 2.07	30 1.18	101.5 3.99	57 2.24	35.5 1.40	32.5 1.28	M10X35	Vds
40X20 1 1/2X3/4	48.3X26.9 1.900X1.050	300 2.07	30 1.18	101.5 3.99	57 2.24	47.5 1.87	32.5 1.28	M10X35	Vds
40X25 1 1/2X1	48.3X33.7 1.900X1.315	300 2.07	30 1.18	101.5 3.99	57 2.24	56 2.20	32.5 1.28	M10X35	Vds
50 x 10 2 x 3/8	60.3 x 17.2 2.375 x 0.677	300 2.07	38 1.50	116 4.57	68 2.68	44 1.73	39 1.54	3/8 x 55 M10X57	—
50 x 15 2 x 1/2	60.3 x 21.3 2.375 x 0.825	300 2.07	38 1.50	116 4.57	68 2.68	60 2.36	39 1.54	3/8 x 55 M10X57	UL FM Vds
50 x 20 2 x 3/4	60.3 x 26.9 2.375 x 1.050	300 2.07	38 1.50	116 4.57	68 2.68	60 2.36	39 1.54	3/8 x 55 M10X57	UL FM Vds
50 x 25 2 x 1	60.3 x 33.7 2.375 x 1.315	300 2.07	38 1.50	116 4.57	68 2.68	60 2.36	39 1.54	3/8 x 55 M10X57	UL FM Vds
50 x 32 2 x 1 1/4	60.3 x 42.4 2.375 x 1.660	300 2.07	45 1.75	116 4.57	76 2.99	65 2.56	39 1.54	3/8 x 55 M10X57	UL FM Vds
50 x 40 2 x 1 1/2	60.3 x 48.3 2.375 x 1.900	300 2.07	45 1.75	116 4.57	76 2.99	65 2.56	39 1.54	3/8 x 55 M10X57	UL FM Vds
65 x 15 2 1/2 x 3/4	73.0 x 21.3 2.875 x 0.825	300 2.07	38 1.50	137 5.39	71 2.76	68 2.67	49 1.93	1/2 x 70 M12X70	UL FM
65 x 20 2 1/2 x 1/2	73.0 x 26.9 2.875 x 1.050	300 2.07	38 1.50	137 5.39	71 2.76	68 2.67	49 1.93	1/2 x 70 M12X70	UL FM
65 x 25 2 1/2 x 1	73.0 x 33.7 2.875 x 1.315	300 2.07	38 1.50	137 5.39	71 2.76	70 2.75	49 1.93	1/2 x 70 M12X70	UL FM
65 x 32 2 1/2 x 1 1/4	73.0 x 42.4 2.875 x 1.660	300 2.07	51 2.00	137 5.397	84.5 3.33	73 2.87	49 1.93	1/2 x 70 M12X70	UL FM
65 x 40 2 1/2 x 1 1/2	73.0 x 48.3 2.875 x 1.900	300 2.07	51 2.00	137 5.39	84.5 3.33	73 2.87	49 1.93	1/2 x 70 M12X70	UL FM
65 x 15 76.1 x 3/4	76.1 x 21.3 3.000 x 0.825	300 2.07	38 1.50	137 5.39	71 2.80	61.5 2.42	49.5 1.95	1/2 x 70 M12X70	UL FM Vds
65 x 20 76.1 x 3/4	76.1 x 26.9 3.000 x 1.050	300 2.07	38 1.50	137 5.39	71 2.80	68 2.67	49.5 1.95	1/2 x 70 M12X70	UL FM Vds
65 x 25 76.1 x 1	76.1 x 33.7 3.000 x 1.315	300 2.07	38 1.50	137 5.39	71 2.80	75 3.05	49.5 1.95	1/2 x 70 M12X70	UL FM Vds
65 x 32 76.1 x 1 1/4	76.1 x 42.4 3.000 x 1.660	300 2.07	51 2.00	137 5.39	84.5 3.33	75 3.05	49.5 1.95	1/2 x 70 M12X70	UL FM Vds
65 x 40 76.1 x 1 1/2	76.1 x 48.3 3.000 x 1.900	300 2.07	51 2.00	137 5.39	84.5 3.33	75 3.05	49.5 1.95	1/2 x 70 M12X70	UL FM Vds
80 x 15 3 x 1/2	88.9 x 21.3 3.500 x 0.825	300 2.07	38 1.50	152 5.98	72.5 2.85	71.5 2.81	56.5 2.22	1/2 x 75 M12X76	UL FM Vds
80 x 20 3 x 3/4	88.9 x 26.9 3.500 x 1.050	300 2.07	38 1.50	152 5.98	72.5 2.85	71.5 2.81	56.5 2.22	1/2 x 75 M12X76	UL FM Vds
80 x 25 3 x 1	88.9 x 33.7 3.500 x 1.315	300 2.07	38 1.50	152 5.98	72.5 2.85	80 3.15	56.5 2.22	1/2 x 75 M12X76	UL FM Vds
80 x 32 3 x 1 1/4	88.9 x 42.4 3.500 x 1.660	300 2.07	51 2.00	152 5.98	85.5 3.37	80 3.15	56.5 2.22	1/2 x 75 M12X76	UL FM Vds
80 x 40 3 x 1 1/2	88.9 x 48.3 3.500 x 1.900	300 2.07	51 2.00	152 5.98	85.5 3.37	80 3.15	56.5 2.22	1/2 x 75 M12X76	UL FM Vds
80 x 50 3 x 2	88.9 x 60.3 3.500 x 2.375	300 2.07	64 2.50	152 5.98	98 3.86	80 3.15	56.5 2.22	1/2 x 75 M12X76	UL FM Vds

3J

Mechanical Tee Threaded Outlet

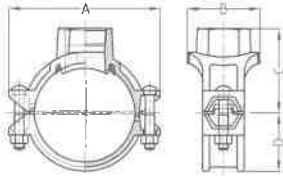

Nominal Size mm/in	Pipe O.D mm/in	Working Pressure PSI/MPa	Hole Dia mm/in +1.6,9/+0.063,0	Dimensions				Bolt Size mm/in	Certificate
				A mm/in	B mm/in	C mm/in	D mm/in		
100×15 108.0×1/2	108.1×21.3 4.250×0.825	300 2.07	38 1.50	172 6.77	78.5 3.09	87 3.43	64.5 2.54	1/2×75 M12X76	UL FM
100×20 108.0×3/4	108.1×26.9 4.250×1.050	300 2.07	38 1.50	172 6.77	78.5 3.09	87 3.43	64.5 2.54	1/2×75 M12X76	UL FM
100×25 108.0×1	108.1×33.7 4.250×1.315	300 2.07	38 1.50	172 6.77	78.5 3.09	87 3.43	64.5 2.54	1/2×75 M12X76	UL FM
100×32 108.0×1¼	108.1×42.4 4.250×1.660	300 2.07	51 2.00	172 6.77	89 3.50	87 3.43	64.5 2.54	1/2×75 M12X76	UL FM
100×40 108.0×1½	108.0×48.3 4.250×1.900	300 2.07	51 2.00	172 6.77	89 3.50	87 3.43	64.5 2.54	1/2×75 M12X76	UL FM
100×50 108.0×2	108.0×60.3 4.250×2.375	300 2.07	64 2.50	172 6.77	106.5 4.19	92 3.62	64.5 2.54	1/2×75 M12X76	UL FM
100×65 108.0×76.1	108.0×76.1 4.250×3.000	300 2.07	70 2.75	172 6.77	106.5 4.19	100 3.94	64.5 2.54	1/2×75 M12X76	UL FM
100×15 4×½	114.3×21.3 4.500×0.825	300 2.07	38 1.50	188 7.40	78.5 3.09	90 3.54	70 2.76	1/2×75 M12X76	UL FM VdS
100×20 4×¾	114.3×26.9 4.500×1.050	300 2.07	38 1.50	188 7.40	78.5 3.09	90 3.54	70 2.76	1/2×75 M12X76	UL FM VdS
100×25 4×1	114.3×33.7 4.500×1.315	300 2.07	38 1.50	188 7.40	78.5 3.09	93 3.66	70 2.76	1/2×75 M12X76	UL FM VdS
100×32 4×1¼	114.3×42.4 4.500×1.660	300 2.07	51 2.00	188 7.40	89 3.50	95 3.74	70 2.76	1/2×75 M12X76	UL FM VdS
100×40 4×1½	114.3×48.3 4.500×1.900	300 2.07	51 2.00	188 7.40	89 3.50	97 3.82	70 2.76	1/2×75 M12X76	UL FM VdS
100×50 4×2	114.3×60.3 4.500×2.375	300 2.07	64 2.50	188 7.40	104.5 4.11	100 3.94	70 2.76	1/2×75 M12X76	UL FM VdS
100×65 4×2½	114.3×73.0 4.500×2.875	300 2.07	70 2.75	188 7.40	104.5 4.11	102 4.02	70 2.76	1/2×75 M12X76	UL FM
100×65 4×76.1	114.3×76.1 4.500×3.000	300 2.07	70 2.75	188 7.40	104.5 4.11	102 4.02	70 2.76	1/2×75 M12X76	UL FM VdS LPCB
100×80 4×3	114.3×88.9 4.500×3.500	300 2.07	89 3.50	188 7.40	128 5.039	102 4.02	70 2.76	1/2×75 M12X76	UL FM VdS LPCB
125×32 133.0×1.25	133.0×42.4 5.250×1.660	300 2.07	51 2.00	209 8.23	93 3.66	105 4.13	77 3.03	5/8×85 M16X85	UL FM
125×40 133.0×1½	133.0×48.3 5.250×1.900	300 2.07	51 2.00	209 8.23	93 3.66	105 4.13	77 3.03	5/8×85 M16X85	UL FM
125×50 133.0×2	133.0×60.3 5.250×2.375	300 2.07	64 2.50	209 8.23	112.5 4.43	110 4.33	77 3.03	5/8×85 M16X85	UL FM
125×15 139.7×1/2	139.7×21.3 5.500×0.825	300 2.07	38 1.50	221.5 8.72	78 3.07	110 4.33	84 3.31	5/8×85 M16X85	UL FM VdS
125×20 139.7×3/4	139.7×26.9 5.500×1.050	300 2.07	38 1.50	221.5 8.72	78 3.07	110 4.33	84 3.31	5/8×85 M16X85	UL FM VdS
125×25 139.7×1	139.7×33.7 5.500×1.315	300 2.07	38 1.50	221.5 8.72	78 3.07	110 4.33	84 3.31	5/8×85 M16X85	UL FM VdS
125×32 139.7×1¼	139.7×42.4 5.500×1.660	300 2.07	51 2.00	221.5 8.72	95 3.74	112 4.41	84 3.31	5/8×85 M16X85	UL FM VdS
125×40 139.7×1½	139.7×48.3 5.500×1.900	300 2.07	51 2.00	221.5 8.72	95 3.74	112 4.41	84 3.31	5/8×85 M16X85	UL FM VdS
125×50 139.7×2	139.7×60.3 5.500×2.375	300 2.07	64 2.50	221.5 8.72	112.5 4.43	115 4.53	84 3.31	5/8×85 M16X85	UL FM VdS
125×65 139.7×76.1	139.7×76.1 5.500×3.000	300 2.07	70 2.75	221.5 8.72	112.5 4.43	115 4.53	84 3.31	5/8×85 M16X85	UL FM VdS LPCB
125×80 139.7×3	139.7×88.9 5.500×3.500	300 2.07	89 3.50	221.5 8.72	132 5.20	120 4.72	84 3.31	5/8×85 M16X85	UL FM VdS LPCB
125×100 139.7×4	139.7×114.3 5.500×4.500	300 2.07	114 4.50	221.5 8.72	156 6.30	125 4.92	84 3.31	5/8×85 M16X85	UL FM VdS LPCB
150×15 159.0×1/2	159.0×21.3 6.250×0.825	300 2.07	38 1.50	244 9.60	78 3.07	116 4.57	94 3.70	5/8×105 M16X108	UL FM
150×25 159.0×1	159.0×33.7 6.250×1.315	300 2.07	38 1.50	244 9.60	78 3.07	116 4.57	94 3.70	5/8×105 M16X108	UL FM
150×32 159.0×1¼	159.0×42.4 6.250×1.660	300 2.07	51 2.00	244 9.60	93 3.66	118 4.65	94 3.70	5/8×105 M16X108	UL FM
150×40 159.0×1½	159.0×48.3 6.250×1.900	300 2.07	51 2.00	244 9.60	93 3.66	118 4.65	94 3.70	5/8×105 M16X108	UL FM

3J

Mechanical Tee Threaded Outlet

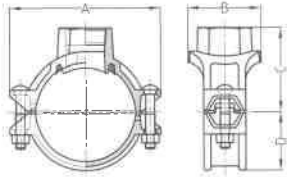

Nominal Size mm/in	Pipe O.D mm/in	Working Pressure PSI/MPa	Hole Dia mm/in +1.6, 0/+0.063, 0	Dimensions				Bolt Size mm/in	Certificate
				A mm/in	B mm/in	C mm/in	D mm/in		
150×50 159.0×2	159.0×60.3 6.250×2.375	300 2.07	64 2.50	244 9.60	112.5 4.43	125 4.92	94 3.70	5/8×105 M16X108	UL FM
150×65 159.0×76.1	159.0×76.1 6.250×3.000	300 2.07	70 2.75	244 9.60	112.5 4.43	125 4.92	94 3.70	5/8×105 M16X108	UL FM
150×80 159.0×88.9	159.0×88.9 6.250×3.500	300 2.07	89 3.50	244 9.60	133 5.20	125 4.92	94 3.70	5/8×105 M16X108	UL FM
150×100 159.0×114.3	159.0×114.3 6.250×4.500	175 1.20	114 4.50	244 9.60	156.5 6.16	130 5.12	94 3.70	5/8×105 M16X108	UL FM
150×15 165.1×1/2	165.1×21.3 6.500×0.825	300 2.07	38 1.50	244 9.60	78 3.07	110 4.33	97.5 3.84	5/8×105 M16X108	UL FM
125×20 165.1×3/4	165.1×26.9 6.500×1.050	300 2.07	38 1.50	244 9.60	78 3.07	110 4.33	97.5 3.84	5/8×105 M16X108	UL FM
150×25 165.1×1	165.1×33.7 6.500×1.315	300 2.07	38 1.50	244 9.60	78 3.07	118 4.65	97.5 3.84	5/8×105 M16X108	UL FM
150×32 165.1×1 1/4	165.1×42.4 6.500×1.660	300 2.07	51 2.00	244 9.60	93 3.66	118 4.65	97.5 3.84	5/8×105 M16X108	UL FM
150×40 165.1×1 1/2	165.1×48.3 6.500×1.900	300 2.07	51 2.00	244 9.60	93 3.66	118 4.65	97.5 3.84	5/8×105 M16X108	UL FM
150×50 165.1×2	165.1×60.3 6.500×2.375	300 2.07	64 2.50	244 9.60	112.5 4.43	128.5 5.43	97.5 3.84	5/8×105 M16X108	UL FM
150×65 165.1×2 1/2	165.1×76.1 6.500×3.000	300 2.07	70 2.75	244 9.60	112.5 4.43	128.5 5.43	97.5 3.84	5/8×105 M16X108	UL FM LPCB
150×80 165.1×3	165.1×88.9 6.500×3.500	300 2.07	89 3.50	244 9.60	132 5.20	128.5 5.06	97.5 3.84	5/8×105 M16X108	UL FM LPCB
150×100 165.1×4	165.1×114.3 6.500×4.500	225 1.6	114 4.50	244 9.60	154 6.18	135 5.32	97.5 3.84	5/8×105 M16X108	UL FM LPCB
150×32 6×1 1/4	168.3×42.4 6.500×1.660	300 2.07	51 2.00	247 9.72	95 3.74	122 4.80	98.5 3.88	5/8×105 M16X108	UL FM Vds
150×40 6×1 1/2	168.3×48.3 6.500×1.900	300 2.07	51 2.00	247 9.72	95 3.74	122 4.80	98.5 3.88	5/8×105 M16X108	UL FM Vds
150×50 6×2	168.3×60.3 6.625×2.375	300 2.07	64 2.50	247 9.72	112.5 4.43	132 5.20	98.5 3.88	5/8×105 M16X108	UL FM Vds
150×65 6×2 1/2	168.3×73.0 6.625×2.875	300 2.07	70 2.75	247 9.72	112.5 4.43	132 5.20	98.5 3.88	5/8×105 M16X108	UL FM
150×65 6×2 1/2	168.3×76.1 6.625×3.000	300 2.07	70 2.75	247 9.72	112.5 4.43	132 5.20	98.5 3.88	5/8×105 M16X108	UL FM Vds LPCB
150×80 6×3	168.3×88.9 6.625×3.500	300 2.07	89 3.50	247 9.72	132 5.20	140 5.51	98.5 3.88	5/8×105 M16X108	UL FM Vds LPCB
150×100 6×4	168.3×114.3 6.625×4.500	300 2.07	114 4.50	247 9.72	160 6.30	140 5.51	98.5 3.88	5/8×105 M16X108	UL FM Vds LPCB
200×25 8×1	219.1×33.7 8.625×1.315	300 2.07	38 1.50	320 12.60	78.5 3.13	150 5.91	125 4.92	3/4×115 M20X115	UL FM Vds
200×32 8×1 1/4	219.1×42.4 8.625×1.660	300 2.07	51 2.00	320 12.60	96.5 3.80	150 5.91	125 4.92	3/4×115 M20X115	UL FM Vds
200×40 8×1 1/2	219.1×48.3 8.625×1.900	300 2.07	51 2.00	320 12.60	96.5 3.80	150 5.91	125 4.92	3/4×115 M20X115	UL FM Vds
200×50 8×2	219.1×60.3 8.625×2.375	300 2.07	64 2.50	320 12.60	117 4.61	160 6.30	125 4.92	3/4×115 M20X115	UL FM Vds
200×65 8×2 1/2	219.1×73.0 8.625×2.875	300 2.07	70 2.75	320 12.60	118 4.65	160 6.30	125 4.92	3/4×115 M20X115	UL FM
200×65 8×2 1/2	219.1×76.1 8.625×3.000	300 2.07	70 2.75	320 12.60	118 4.65	160 6.30	125 4.92	3/4×115 M20X115	UL FM Vds LPCB
200×80 8×3	219.1×88.9 8.625×3.500	300 2.07	89 3.50	320 12.60	136.5 5.37	160 6.30	125 4.92	3/4×115 M20X115	UL FM Vds LPCB
200×100 8×4	219.1×114.3 8.625×4.500	300 2.07	114 4.50	320 12.60	164 6.46	160 6.30	125 4.92	3/4×115 M20X115	UL FM Vds LPCB
250×40 10×1 1/2	273.0×48.3 10.750×1.900	300 2.07	51 2.00	376 14.80	96.5 3.76	180 7.09	155 6.10	3/4×120 M20X115	UL FM
250×50 10×2	273.0×60.3 10.750×2.375	300 2.07	64 2.50	376 14.80	118 4.65	185 7.28	155 6.10	3/4×120 M20X115	UL FM Vds
250×65 10×2 1/2	273.0×76.1 10.750×3.000	300 2.07	70 2.75	376 14.80	118 4.65	190 7.48	155 6.10	3/4×120 M20X115	UL FM Vds
250×80 10×3	273.0×88.9 10.750×3.500	300 2.07	89 3.50	376 14.80	136.5 5.37	190 7.48	155 6.10	3/4×120 M20X115	UL FM Vds
250×100 10×4	273.0×114.3 10.750×4.500	300 2.07	114 4.50	376 14.80	164 6.46	190 7.48	155 6.10	3/4×120 M20X115	UL FM Vds

3JS

Light-duty
Mechanical Tee
Threaded Outlet

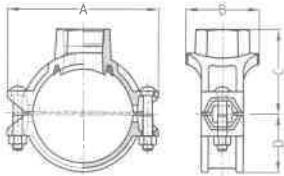

Nominal Size mm/in	Pipe O.D mm/in	Working Pressure PSI/MPa	Hole Dia mm/in +1.6,0/+0.063,0	Dimensions				Bolt Size mm/in	Certificate
				A mm/in	B mm/in	C mm/in	D mm/in		
80×15 3×½	88.9×21.3 3.500×0.825	300 2.07	38 1.50	150 5.91	71.0 2.80	68 2.68	55.5 2.19	1/2×75 M12X76	UL FM
80×20 3×¾	88.9×26.9 3.500×1.050	300 2.07	38 1.50	150 5.91	71.0 2.80	68 2.68	55.5 2.19	1/2×75 M12X76	UL FM
80×25 3×1	88.9×33.7 3.500×1.315	300 2.07	38 1.50	150 5.91	71.0 2.80	71.0 2.80	55.5 2.19	1/2×75 M12X76	UL FM
80×32 3×1¼	88.9×42.4 3.500×1.660	300 2.07	51 2.00	150 5.91	84.5 3.33	74 2.91	55.5 2.19	1/2×75 M12X76	UL FM
80×40 3×1½	88.9×48.3 3.500×1.900	300 2.07	51 2.00	150 5.91	84.5 3.33	74 2.91	55.5 2.19	1/2×75 M12X76	UL FM
80×50 3×2	88.9×60.3 3.500×2.375	300 2.07	64 2.50	150 5.91	98 3.86	77 3.03	55.5 2.19	1/2×75 M12X76	UL FM
100×15 108.0×½	108.1×21.3 4.250×0.825	300 2.07	38 1.50	172 6.77	77.5 3.05	85 3.35	64.5 2.54	1/2×75 M12X76	UL FM
100×25 108.0×1	108.1×33.7 4.250×1.315	300 2.07	38 1.50	172 6.77	77.5 3.05	85 3.35	64.5 2.54	1/2×75 M12X76	UL FM
100×32 108.0×1¼	108.1×42.4 4.250×1.660	300 2.07	51 2.00	172 6.77	88 3.46	85 3.35	64.5 2.54	1/2×75 M12X76	UL FM
100×40 108.0×1½	108.0×48.3 4.250×1.900	300 2.07	51 2.00	172 6.77	88 3.46	85 3.35	64.5 2.54	1/2×75 M12X76	UL FM
100×50 108.0×2	108.0×60.3 4.250×2.375	300 2.07	64 2.50	172 6.77	103.5 4.19	90.5 3.56	64.5 2.54	1/2×75 M12X76	UL FM
100×65 108.0×76.1	108.0×76.1 4.250×3.000	300 2.07	70 2.75	172 6.77	103.5 4.07	97.5 3.84	64.5 2.54	1/2×75 M12X76	UL FM
100×25 4×1	114.3×33.7 4.500×1.315	300 2.07	38 1.50	178 7.01	77.5 3.05	89.5 3.52	67.5 2.66	1/2×75 M12X76	UL FM
100×32 4×1¼	114.3×42.4 4.500×1.660	300 2.07	51 2.00	178 7.01	88 3.46	89.5 3.53	67.5 2.66	1/2×75 M12X76	UL FM
100×40 4×1½	114.3×48.3 4.500×1.900	300 2.07	51 2.00	178 7.01	88 3.46	89.5 3.53	67.5 2.66	1/2×75 M12X76	UL FM
100×50 4×2	114.3×60.3 4.500×2.375	300 2.07	64 2.50	178 7.01	103.5 4.07	92 3.62	67.5 2.66	1/2×75 M12X76	UL FM
100×65 4×2½	114.3×73.0 4.500×2.875	300 2.07	70 2.75	178 7.01	103.5 4.07	98 3.86	67.5 2.66	1/2×75 M12X76	UL FM
100×65 4×76.1	114.3×76.1 4.500×3.000	300 2.07	70 2.75	178 7.01	103.5 4.07	98 3.86	67.5 2.66	1/2×75 M12X76	UL FM
100×80 4×3	114.3×88.9 4.500×3.500	300 2.07	89 3.50	178 7.01	124 4.88	98 3.86	67.5 2.66	1/2×75 M12X76	UL FM
125×25 133.0×1	133.0×33.7 5.250×1.315	300 2.07	38 1.50	203 7.99	77 3.03	98 3.86	77.5 3.05	5/8×85	UL FM
125×32 133.0×1.25	133.0×42.4 5.250×1.660	300 2.07	51 2.00	203 7.99	91 3.58	102 4.01	77.5 3.05	5/8×85	UL FM
125×40 133.0×1½	133.0×48.3 5.250×1.900	300 2.07	51 2.00	203 7.99	91 3.58	102 4.01	77.5 3.05	5/8×85	UL FM
125×50 133.0×2	133.0×60.3 5.250×2.375	300 2.07	64 2.50	203 7.99	110 4.33	105 4.13	77.5 3.05	5/8×85	UL FM
125×65 133.0×76.1	133.0×76.1 5.250×3.000	300 2.07	70 2.75	203 7.99	110 4.33	113 4.45	77.5 3.05	5/8×85	UL FM
125×80 133.0×3	133.0×88.9 5.250×3.500	300 2.07	89 3.50	203 7.99	132 5.12	110 4.33	77.5 3.05	5/8×85	UL FM
125×25 139.7×1	139.7×33.7 5.500×1.315	300 2.07	38 1.50	210 8.27	77 3.03	100 3.94	82 3.23	5/8×85 M16X85	UL FM
125×32 139.7×1¼	139.7×42.4 5.500×1.660	300 2.07	51 2.00	210 8.27	91 3.58	105 4.13	82 3.23	5/8×85 M16X85	UL FM
125×40 139.7×1½	139.7×48.3 5.500×1.900	300 2.07	51 2.00	210 8.27	91 3.58	105 4.13	82 3.23	5/8×85 M16X85	UL FM
125×50 139.7×2	139.7×60.3 5.500×2.375	300 2.07	64 2.50	210 8.27	110 4.33	108 4.25	82 3.23	5/8×85 M16X85	UL FM
125×65 139.7×76.1	139.7×76.1 5.500×3.000	300 2.07	70 2.75	210 8.27	110 4.33	115 4.53	82 3.23	5/8×85 M16X85	UL FM
125×80 139.7×3	139.7×88.9 5.500×3.500	300 2.07	89 3.50	210 8.27	130 5.12	115 4.53	82 3.23	5/8×85 M16X85	UL FM
125×100 139.7×4	139.7×114.3 5.500×4.500	300 2.07	114 4.50	210 8.27	153 6.02	118 4.65	82 3.23	5/8×85 M16X85	UL FM
125×32 5×1¼	141.3×42.4 5.563×1.660	300 2.07	51 2.00	210 8.27	91 3.58	105 4.13	82 3.23	5/8×85 M16X85	—
125×40 5×1½	141.3×48.3 5.563×1.900	300 2.07	51 2.00	210 8.27	91 3.58	105 4.13	82 3.23	5/8×85 M16X85	—
125×50 5×2	141.3×60.3 5.563×2.375	300 2.07	64 2.50	210 8.27	110 4.33	108 4.25	82 3.23	5/8×85 M16X85	—

3JS

Light-duty Mechanical Tee Threaded Outlet

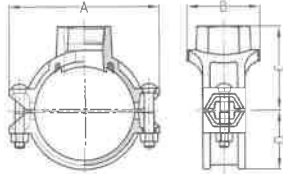

Nominal Size mm/in	Pipe O.D mm/in	Working Pressure PSI/MPa	Hole Dia mm/in +1.6,0/+0.063,0	Dimensions				Bolt Size mm/in	Certificate
				A mm/in	B mm/in	C mm/in	D mm/in		
150×25 159.0×1	159.0×33.7 6.250×1.315	300 2.07	38 1.50	227 8.94	77 3.03	110 4.33	91 3.58	5/8×85 M16X85	UL FM
150×32 159.0×1¼	159.0×42.4 6.250×1.660	300 2.07	51 2.00	227 8.94	92.5 3.64	112 4.41	91 3.58	5/8×105 M16X108	UL FM
150×40 159.0×1½	159.0×48.3 6.250×1.900	300 2.07	51 2.00	227 8.94	92.5 3.64	112 4.41	91 3.58	5/8×105 M16X108	UL FM
150×50 159.0×2	159.0×60.3 6.250×2.375	300 2.07	64 2.50	227 8.94	110 4.33	116.5 4.59	91 3.58	5/8×105 M16X108	UL FM
150×65 159.0×76.1	159.0×76.1 6.250×3.000	300 2.07	70 2.75	227 8.94	110 4.33	121.5 4.78	91 3.58	5/8×105 M16X108	UL FM
150×80 159.0×3	159.0×88.9 6.250×3.500	300 2.07	89 3.50	227 8.94	130 5.12	123.5 4.86	91 3.58	5/8×105 M16X108	UL FM
150×100 159.0×4	159.1×114.3 6.250×4.500	300 2.07	114 4.50	227 8.94	155 6.10	127 5.00	91 3.58	5/8×105 M16X108	UL FM
150×15 165.1×½	165.1×21.3 6.500×0.825	300 2.07	38 1.50	235 9.25	77 3.03	115 4.53	94.5 3.72	5/8×105 M16X108	UL FM
125×20 165.1×¾	165.1×26.9 6.500×1.050	300 2.07	38 1.50	235 9.25	77 3.03	115 4.53	94.5 3.72	5/8×105 M16X108	UL FM
150×25 165.1×1	165.1×33.7 6.500×1.315	300 2.07	38 1.50	235 9.25	77 3.03	115 4.53	94.5 3.72	5/8×105 M16X108	UL FM
150×32 165.1×1¼	165.1×42.4 6.500×1.660	300 2.07	51 2.00	235 9.25	92.5 3.64	115 4.53	94.5 3.72	5/8×105 M16X108	UL FM
150×40 165.1×1½	165.1×48.3 6.500×1.900	300 2.07	51 2.00	235 9.25	92.5 3.64	115 4.53	94.5 3.72	5/8×105 M16X108	UL FM
150×50 165.1×2	165.1×60.3 6.500×2.375	300 2.07	64 2.50	235 9.25	110 4.33	120 4.72	94.5 3.72	5/8×105 M16X108	UL FM
150×65 165.1×76.1	165.1×76.1 6.500×3.000	300 2.07	70 2.75	235 9.25	110 4.33	125 4.92	94.5 3.72	5/8×105 M16X108	UL FM
150×80 165.1×3	165.1×88.9 6.500×3.500	300 2.07	89 3.50	235 9.25	130 5.12	125 4.92	94.5 3.72	5/8×105 M16X108	UL FM
150×100 165.1×4	165.1×114.3 6.500×4.500	300 2.07	114 4.50	240 9.45	155 6.10	130 5.12	94.5 3.72	5/8×105 M16X108	UL FM
150×25 6×1	168.3×33.7 6.500×1.315	300 2.07	38 1.50	240 9.45	77 3.03	115 4.53	96.5 3.80	5/8×105 M16X108	UL FM
150×32 6×1¼	168.3×42.4 6.500×1.660	300 2.07	51 2.00	240 9.45	92.5 3.64	115 4.53	96.5 3.80	5/8×105 M16X108	UL FM
150×40 6×1½	168.3×48.3 6.500×1.900	300 2.07	51 2.00	240 9.45	92.5 3.64	115 4.53	96.5 3.80	5/8×105 M16X108	UL FM
150×50 6×2	168.3×60.3 6.625×2.375	300 2.07	64 2.50	240 9.45	110 4.33	121 4.76	96.5 3.80	5/8×105 M16X108	UL FM
150×65 6×2½	168.3×73.0 6.625×2.875	300 2.07	70 2.75	240 9.45	110 4.33	127 5.00	96.5 3.80	5/8×105 M16X108	UL FM
150×65 6×2½	168.3×76.0 6.625×3.000	300 2.07	70 2.75	240 9.45	110 4.33	127 5.00	96.5 3.80	5/8×105 M16X108	—
150×80 6×3	168.3×88.9 6.625×3.500	300 2.07	89 3.50	240 9.45	130 5.12	127 5.00	96.5 3.80	5/8×105 M16X108	UL FM
150×100 6×4	168.3×114.3 6.625×4.500	300 2.07	114 4.50	240 9.45	155 6.10	130 5.12	96.5 3.80	5/8×105 M16X108	UL FM
200×25 8×1	219.0×33.7 8.625×1.315	300 2.07	38 1.50	300 11.81	78 3.07	140 5.51	123 4.84	5/8×105 M16X108	UL FM
200×32 8×1¼	219.1×42.4 8.625×1.660	300 2.07	51 2.00	300 11.81	96.5 3.80	140 5.51	123 4.84	5/8×105 M16X108	UL FM
200×40 8×1½	219.1×48.3 8.625×1.900	300 2.07	51 2.00	300 11.81	96.5 3.80	143 5.63	123 4.84	5/8×105 M16X108	UL FM
200×50 8×2	219.1×60.3 8.625×2.375	300 2.07	64 2.50	300 11.81	117 4.61	149 5.87	123 4.84	5/8×105 M16X108	UL FM
200×65 8×2½	219.1×73.0 8.625×2.875	300 2.07	70 2.75	300 11.81	117 4.61	155 6.10	123 4.84	5/8×105 M16X108	UL FM
200×65 8×76.1	219.1×76.1 8.625×3.000	300 2.07	70 2.75	300 11.81	117 4.61	155 6.10	123 4.84	5/8×105 M16X108	UL FM
200×80 8×3	219.1×88.9 8.625×3.500	300 2.07	89 3.50	300 11.81	133.5 5.25	155 6.10	123 4.84	5/8×105 M16X108	UL FM
200×100 8×4	219.1×114.3 8.625×4.500	300 2.07	114 4.50	300 11.81	164 6.45	160 6.30	123 4.84	5/8×105 M16X108	UL FM

4G

Mechanical Cross Grooved Outlet

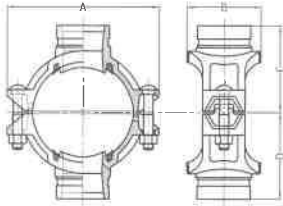

Nominal Size mm/in	Pipe O.D mm/in	Working Pressure PSI/MPa	Hole Dia mm/in +1.6,0/+0.063,0	Dimensions				Bolt Size mm/in
				A mm/in	B mm/in	C mm/in	D mm/in	
65×32 2½×1¼	73.0×42.4 2.875×1.669	300 2.07	51 2	144 5.67	84.5 3.33	75 2.95	75 2.95	1/2×70 M12X70
65×25 2½×1	76.1×33.7 3.000×1.327	300 2.07	38 1.5	137 5.39	71 2.8	78 3.07	78 3.07	1/2×70 M12X70
65×32 2½×1¼	76.1×42.4 3.000×1.669	300 2.07	51 2	137 5.39	84.5 3.33	78 3.07	78 3.07	1/2×70 M12X70
80×25 3×1	88.9×33.7 3.500×1.327	300 2.07	38 1.5	152 5.98	72.5 2.85	84.5 3.33	84.5 3.33	1/2×75 M12X76
80×32 3×1¼	88.9×42.4 3.500×1.669	300 2.07	51 2	152 5.98	85.5 3.37	84.5 3.33	84.5 3.33	1/2×75 M12X76
80×40 3×1½	88.9×48.3 3.500×1.900	300 2.07	51 2	152 5.98	85.5 3.37	84.5 3.33	84.5 3.33	1/2×75 M12X76
100×25 4×1	114.3×33.7 4.500×1.327	300 2.07	38 1.5	188 7.4	78.4 3.09	102 4.02	102 4.02	1/2×75 M12X76
100×40 4×1½	114.3×48.3 4.500×1.900	300 2.07	51 2	188 7.4	89 3.5	102 4.02	102 4.02	1/2×75 M12X76
100×50 4×2	114.3×60.3 4.500×2.375	300 2.07	64 2.5	188 7.4	104.5 4.11	102 4.02	102 4.02	1/2×75 M12X76
125×50 5×2	139.7×60.3 5.500×2.375	300 2.07	64 2.5	221.5 8.72	112.5 4.43	118 4.65	118 4.65	5/8X85 M16X85
125×65 5×2½	139.7×76.1 5.500×3.000	300 2.07	70 2.75	221.5 8.72	112.5 4.43	118 4.65	118 4.65	5/8X85 M16X85
150×50 6×2	165.1×60.3 6.500×2.375	300 2.07	64 2.5	244 9.6	112.5 4.43	127 5	127 5	5/8X105
150×65 6×2½	165.1×76.1 6.500×3.000	300 2.07	70 2.75	244 9.6	112.5 4.43	127 5	127 5	5/8X105 M16X108
150×80 6×3	165.1×88.9 6.500×3.500	300 2.07	89 3.5	244 9.6	132 5.2	141 5.55	141 5.55	5/8X105 M16X108
150×40 6×1½	168.3×48.3 6.625×1.900	300 2.07	51 2	247 9.72	95 3.74	128 5.04	128 5.04	5/8X105 M16X108
150×50 6×2	168.3×60.3 6.625×2.375	300 2.07	64 2.5	247 9.72	114 4.49	134 5.28	134 5.28	5/8X105 M16X108
150×65 6×2½	168.3×73.0 6.625×2.875	300 2.07	70 2.75	247 9.72	115 4.53	134 5.28	134 5.28	5/8X105 M16X108
150×80 6×3	168.3×88.9 6.625×3.500	300 2.07	89 3.5	247 9.72	132 5.2	141 5.55	141 5.55	5/8X105 M16X108
200×50 8×2	219.1×60.3 8.625×2.375	300 2.07	64 2.5	320 12.6	118 4.65	158 6.22	158 6.22	3/4X115 M20X115
200×65 8×2½	219.1×76.1 8.625×3.000	300 2.07	70 2.75	320 12.6	118 4.65	158 6.22	158 6.22	3/4X115 M20X115
200×80 8×3	219.1×88.9 8.625×3.500	300 2.07	89 3.5	320 12.6	136.5 5.37	161 6.34	161 6.34	3/4X115 M20X115
200×100 8×4	219.1×114.3 8.625×4.500	300 2.07	114 4.5	320 12.6	162 6.38	161 6.34	161 6.34	3/4X115 M20X115
250×65 10×2½	273.0×76.1 10.750×3.000	300 2.07	70 2.75	376 14.8	118 4.65	189 7.44	189 7.44	3/4X120 M20X115
250×80 10×3	273.0×88.9 10.750×3.500	300 2.07	89 3.5	376 14.8	136.5 5.37	189 7.44	189 7.44	3/4X120 M20X115
250×100 10×4	273.0×114.3 10.750×4.500	300 2.07	114 4.5	376 14.8	164 6.46	189 7.44	189 7.44	3/4X120 M20X115

4GS

Light-duty
Mechanical Cross
Grooved Outlet

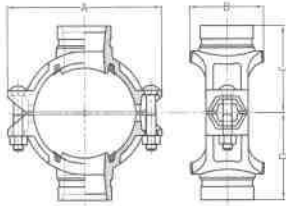

Nominal Size mm/in	Pipe O.D mm/in	Working Pressure PSI/MPa	Hole Dia mm/in +1.6, 0/+0.063, 0	Dimensions				Bolt Size mm/in
				A mm/in	B mm/in	C mm/in	D mm/in	
80×25 3×1	88.9×33.7 3.500×1.315	300 2.07	38 1.50	150 5.91	71.0 2.80	84 3.31	84 3.31	1/2×70 M12X76
80×32 3×1¼	88.9×42.4 3.500×1.660	300 2.07	51 2.00	150 5.91	84.5 3.33	84 3.31	84 3.31	1/2×70 M12X76
80×40 3×1½	88.9×48.3 3.500×1.900	300 2.07	51 2.00	150 5.91	84.5 3.33	84 3.31	84 3.31	1/2×70 M12X76
100×25 4×1	114.3×33.7 4.500×1.315	300 2.07	38 1.50	178 7.01	77.5 3.05	98 3.86	98 3.86	1/2×70 M12X76
100×40 4×1½	114.3×48.3 4.500×1.900	300 2.07	51 2.00	178 7.01	88 3.46	98 3.86	98 3.86	1/2×70 M12X76
100×50 4×2	114.3×60.3 4.500×2.375	300 2.07	64 2.50	178 7.01	103.5 4.07	98 3.86	98 3.86	1/2×70 M12X76
125×50 139.7×2	139.7×60.3 5.500×2.375	300 2.07	64 2.50	210 8.27	110 4.33	113 4.45	113 4.45	5/8×85 M16X85
125×65 139.7×76.1	139.7×76.1 5.500×3.000	300 2.07	70 2.75	210 8.27	110 4.33	113 4.45	113 4.45	5/8×85 M16X85
150×50 165.1×2	165.1×60.3 6.500×2.375	300 2.07	64 2.50	235 9.25	110 4.33	124.5 4.90	124.5 4.90	5/8×105 M16X108
150×65 165.1×76.1	165.1×76.1 6.500×3.000	300 2.07	70 2.75	235 9.25	110 4.33	124.5 4.90	124.5 4.90	5/8×105 M16X108
150×80 165.1×3	165.1×88.9 6.500×3.500	300 2.07	89 3.50	235 9.25	130 5.12	124.5 4.90	124.5 4.90	5/8×105 M16X108
150×32 6×1¼	168.3×42.4 6.500×1.660	300 2.07	51 2.00	240 9.45	92.5 3.64	126 4.96	126 4.96	5/8×105 M16X108
150×40 6×1½	168.3×48.3 6.500×1.900	300 2.07	51 2.00	240 9.45	92.5 3.64	126 4.96	126 4.96	5/8×105 M16X108
150×50 6×2	168.3×60.3 6.625×2.375	300 2.07	64 2.50	240 9.45	110 4.33	126 4.96	126 4.96	5/8×105 M16X108
150×65 6×2½	168.3×73.0 6.625×2.875	300 2.07	70 2.75	240 9.45	110 4.33	126 4.96	126 4.96	5/8×105 M16X108
150×80 6×3	168.3×88.9 6.625×3.500	300 2.07	89 3.50	240 9.45	130 5.12	126 4.96	126 4.96	5/8×105 M16X108
200×50 8×2	219.1×60.3 8.625×2.375	300 2.07	64 2.50	300 11.81	115 4.53	155 6.10	155 6.10	5/8×105 M16X108
200×65 8×76.1	219.1×76.1 8.625×3.000	300 2.07	70 2.75	300 11.81	115 4.53	155 6.10	155 6.10	5/8×105 M16X108
200×80 8×3	219.1×88.9 8.625×3.500	300 2.07	89 3.50	300 11.81	133.5 5.25	155 6.10	155 6.10	5/8×105 M16X108
200×100 8×4	219.1×114.3 8.625×4.500	300 2.07	114 4.50	300 11.81	169.5 6.29	160 6.30	160 6.30	5/8×105 M16X108

4J

Mechanical Cross Threaded Outlet

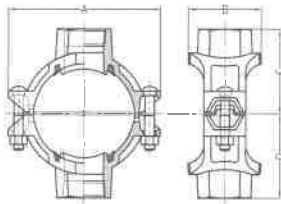

Nominal Size mm/in	Pipe O.D. mm/in	Working Pressure PSI/MPa	Hole Dia mm/in +1.6,0/+0.063,0	Dimensions				Bolt Size mm/in
				A mm/in	B mm/in	C mm/in	D mm/in	
65×20 2½×¾	73.0×26.9 2.875×1.050	300 2.07	38 1.50	137 5.39	71 2.80	66 2.68	68 2.68	1/2×70 M12X70
65×25 2½×1	73.0×33.7 2.875×1.315	300 2.07	38 1.50	137 5.39	71 2.80	70 2.76	70 2.76	1/2×70 M12X70
65×32 2½×1¼	73.0×42.4 2.875×1.660	300 2.07	51 2.00	137 5.39	84.5 3.33	73 2.87	73 2.87	1/2×70 M12X70
65×15 2½×½	76.1×21.3 3.000×0.825	300 2.07	38 1.5	137 5.39	71 2.8	61.5 2.42	61.5 2.42	1/2X70 M12X70
65×20 2½×¾	76.1×26.9 3.000×1.059	300 2.07	38 1.5	137 5.39	71 2.8	75 3.05	75 3.05	1/2X70 M12X70
65×25 2½×1	76.1×33.7 3.000×1.327	300 2.07	38 1.5	137 5.39	71 2.8	75 3.05	75 3.05	1/2X70 M12X70
65×32 2½×1¼	76.1×42.4 3.000×1.669	300 2.07	51 2	137 5.39	84.5 3.33	75 3.05	75 3.05	1/2X70 M12X70
80×15 3×½	88.9×21.3 3.500×0.825	300 2.07	38 1.5	152 5.98	72.5 2.85	71.5 2.81	71.5 2.81	1/2X75 M12X76
80X20 3×¾	88.9×26.9 3.500×1.059	300 2.07	38 1.5	152 5.98	72.5 2.85	71.5 2.81	71.5 2.81	1/2X75 M12X76
80×25 3×1	88.9×33.7 3.500×1.327	300 2.07	38 1.5	152 5.98	72.5 2.85	80 3.15	80 3.15	1/2X75 M12X76
80×32 3×1¼	88.9×42.4 3.500×1.669	300 2.07	51 2	152 5.98	85.5 3.37	80 3.15	80 3.15	1/2X75 M12X76
80×40 3×1½	88.9×48.3 3.500×1.900	300 2.07	51 2	152 5.98	85.5 3.37	80 3.15	80 3.15	1/2X75 M12X76
100×32 106.0×1¼	108.1×42.4 4.250×1.660	300 2.07	51 2.00	172 6.77	89 3.50	87 3.43	87 3.43	1/2×75 M12X76
100×40 108.0×1½	108.0×48.3 4.250×1.900	300 2.07	51 2.00	172 6.77	89 3.50	87 3.43	87 3.43	1/2×75 M12X76
100×50 108.0×2	108.0×60.3 4.250×2.375	300 2.07	64 2.50	172 6.77	106.5 4.19	92 3.62	92 3.62	1/2×75 M12X76
100×15 4×½	114.3×21.3 4.500×0.825	300 2.07	38 1.5	188 7.4	78.5 3.09	90 3.54	90 3.54	1/2X75 M12X76
100×20 4×¾	114.3×26.9 4.500×1.059	300 2.07	38 1.5	188 7.4	78.5 3.09	90 3.54	90 3.54	1/2X75 M12X76
100×25 4×1	114.3×33.7 4.500×1.327	300 2.07	38 1.5	188 7.4	78.5 3.09	93 3.66	93 3.66	1/2X75 M12X76
100×32 4×1¼	114.3×42.4 4.500×1.669	300 2.07	51 2	188 7.4	89 3.5	95 3.74	95 3.74	1/2X75 M12X76
100×40 4×1½	114.3×48.3 4.500×1.900	300 2.07	51 2	188 7.4	89 3.5	97 3.82	97 3.82	1/2X75 M12X76
100×50 4×2	114.3×60.3 4.500×2.375	300 2.07	64 2.5	188 7.4	104.5 4.11	100 3.94	100 3.94	1/2X75 M12X76
125×50 133.0×2	133.0×60.3 5.250×2.375	300 2.07	64 2.50	209 8.23	112.5 4.43	110 4.33	110 4.33	5/8×85 M16X85
125×25 5×1	139.7×33.7 5.500×1.327	300 2.07	38 1.5	221.5 8.72	78 3.07	110 4.33	110 4.33	5/8X85 M16X85
125×32 5×1¼	139.7×42.4 5.500×1.669	300 2.07	51 2	221.5 8.72	95 3.74	112 4.41	112 4.41	5/8X85 M16X85
125×40 5×1½	139.7×48.3 5.500×1.900	300 2.07	51 2	221.5 8.72	95 3.74	112 4.41	112 4.41	5/8X85 M16X85
125×50 5×2	139.7×60.3 5.500×2.375	300 2.07	64 2.5	221.5 8.72	112.5 4.43	115 4.53	115 4.53	5/8X85 M16X85
125×65 5×2½	139.7×76.1 5.500×3.000	300 2.07	70 2.75	221.5 8.72	112.5 4.43	115 4.53	115 4.53	5/8X85 M16X85
150×32 159.0×1¼	159.0×42.4 6.250×1.660	300 2.07	51 2.00	244 9.60	93 3.66	118 4.65	118 4.65	5/8×105 M16X108

4J

Mechanical Cross Threaded Outlet

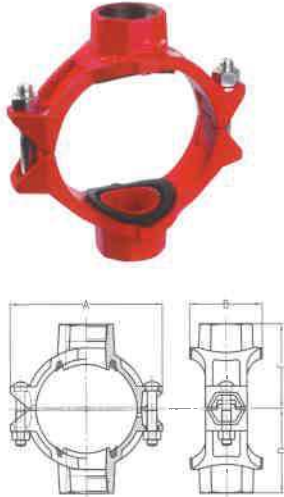

Nominal Size mm/in	Pipe O.D mm/in	Working Pressure PSI/MPa	Hole Dia mm/in +1.6,0/+0.063,0	Dimensions				Bolt Size mm/in
				A mm/in	B mm/in	C mm/in	D mm/in	
150×40 159.0×1½	159.0×48.3 6.250×1.900	300 2.07	51 2.00	244 9.60	93 3.66	118 4.65	118 4.65	5/8×105 M16X108
150×50 159.0×2	159.0×60.3 6.250×2.375	300 2.07	64 2.50	244 9.60	112.5 4.43	125 4.92	125 4.92	5/8×105 M16X108
150×65 159.0×76.1	159.0×76.1 6.250×3.000	300 2.07	70 2.75	244 9.60	112.5 4.43	125 4.92	125 4.92	5/8×105 M16X108
150×15 6×½	165.1×21.3 6.500×0.825	300 2.07	38 1.5	244 9.6	78 3.07	110 4.33	110 4.33	5/8X105 M16X108
150×20 6×¾	165.1×26.9 6.500×1.059	300 2.07	38 1.5	244 9.6	78 3.07	110 4.33	110 4.33	5/8X105 M16X108
150×25 6×1	165.1×33.7 6.500×1.327	300 2.07	38 1.5	244 9.6	78 3.07	118 4.65	118 4.65	5/8X105 M16X108
150×32 6×1¼	165.1×42.4 6.500×1.669	300 2.07	51 2	244 9.6	93 3.66	118 4.65	118 4.65	5/8X105 M16X108
150×40 6×1½	165.1×48.3 6.500×1.900	300 2.07	51 2	244 9.6	93 3.66	118 4.65	118 4.65	5/8X105 M16X108
150×50 6×2	165.1×60.3 6.500×2.375	300 2.07	64 2.5	244 9.6	112.5 4.43	128.5 5.43	128.5 5.43	5/8X105 M16X108
150×65 6×2½	165.1×76.1 6.500×3.000	300 2.07	70 2.75	244 9.6	112.5 4.43	128.5 5.43	128.5 5.43	5/8X105 M16X108
150×80 6×3	165.1×88.9 6.500×3.500	300 2.07	89 3.5	244 9.6	132 5.2	128.5 5.06	128.5 5.06	5/8X105 M16X108
150×32 6×1¼	168.3×42.4 6.500×1.669	300 2.07	51 2	247 9.72	95 3.74	130 5.12	130 5.12	5/8X105 M16X108
150×40 6×1½	168.3×48.3 6.500×1.900	300 2.07	51 2	247 9.72	95 3.74	122 4.8	122 4.8	5/8X105 M16X108
150×50 6×2	168.3×60.3 6.625×2.375	300 2.07	64 2.5	247 9.72	112.5 4.43	132 5.2	132 5.2	5/8X105 M16X108
150×65 6×2½	168.3×73.0 6.625×2.875	300 2.07	70 2.75	247 9.72	112.5 4.43	132 5.2	132 5.2	5/8X105 M16X108
150×80 6×3	168.3×88.9 6.625×3.500	300 2.07	89 3.5	247 9.72	132 5.2	140 5.51	140 5.51	5/8X105 M16X108
200×25 8×1	219.0×33.7 8.625×1.327	300 2.07	38 1.5	320 12.60	79.5 3.13	150 5.91	150 5.91	3/4X115 M20X115
200×32 8×1¼	219.1×42.4 8.625×1.669	300 2.07	51 2	320 12.60	96.5 3.8	150 5.91	150 5.91	3/4X115 M20X115
200×40 8×1½	219.1×48.3 8.625×1.900	300 2.07	51 2	320 12.60	96.5 3.8	150 5.91	150 5.91	3/4X115 M20X115
200×50 8×2	219.1×60.3 8.625×2.375	300 2.07	64 2.5	320 12.60	117 4.61	160 6.3	160 6.3	3/4X115 M20X115
200×65 8×2½	219.1×76.1 8.625×3.000	300 2.07	70 2.75	320 12.60	118 4.65	158.5 6.24	158.5 6.24	3/4X115 M20X115
200×80 8×3	219.1×88.9 8.625×3.500	300 2.07	89 3.5	320 12.60	136.5 5.37	160 6.3	160 6.3	3/4X115 M20X115
200×100 8×4	219.1×114.3 8.625×4.500	300 2.07	114 4.5	320 12.60	164 6.46	160 6.3	160 6.3	3/4X115 M20X115
250×40 10×1½	273.0×48.3 10.750×1.900	300 2.07	51 2	376 14.8	95.5 3.76	180 7.09	180 7.09	3/4X120 M20X115
250×50 10×2	273.0×60.3 10.750×2.375	300 2.07	64 2.5	376 14.8	118 4.65	185 7.28	185 7.28	3/4X120 M20X115
250×65 10×2½	273.0×76.1 10.750×3.000	300 2.07	70 2.75	376 14.8	118 4.65	190 7.48	190 7.48	3/4X120 M20X115
250×80 10×3	273.0×88.9 10.750×3.500	300 2.07	89 3.5	376 14.8	136.5 5.37	190 7.48	190 7.48	3/4X120 M20X115
250×100 10×4	273.0×114.3 10.750×4.500	300 2.07	114 4.5	376 14.8	164 6.46	190 7.48	190 7.48	3/4X120 M20X115

4JS

Light-duty
Mechanical Cross
Threaded Outlet

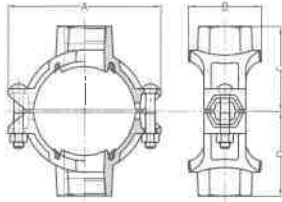

Nominal Size mm/in	Pipe O.D mm/in	Working Pressure PSI/MPa	Hole Dia mm/in +1.6,0/+0.063,0	Dimensionsmm/in				Bolt Size mm/in
				A mm/in	B mm/in	C mm/in	D mm/in	
80×15 3×½	88.9×21.3 3.500×0.825	300 2.07	38 1.50	150 5.91	71.0 2.80	68 2.68	68 2.68	1/2×75 M12X76
80×20 3×¾	88.9×26.9 3.500×1.050	300 2.07	38 1.50	150 5.91	71.0 2.80	68 2.68	68 2.68	1/2×75 M12X76
80×25 3×1	88.9×33.7 3.500×1.315	300 2.07	38 1.50	150 5.91	71.0 2.80	71.0 2.80	71.0 2.80	1/2×75 M12X76
80×32 3×1¼	88.9×42.4 3.500×1.660	300 2.07	51 2.00	150 5.91	84.5 3.33	74 2.91	74 2.91	1/2×75 M12X76
80×40 3×1½	88.9×48.3 3.500×1.900	300 2.07	51 2.00	150 5.91	84.5 3.33	74 2.91	74 2.91	1/2×75 M12X76
100×25 108.0×1	108.1×33.7 4.250×1.315	300 2.07	38 1.50	172 6.77	77.5 3.05	85 3.35	85 3.35	1/2×75 M12X76
100×32 108.0×1¼	108.1×42.4 4.250×1.660	300 2.07	51 2.00	172 6.77	88 3.46	85 3.35	85 3.35	1/2×75 M12X76
100×40 108.0×1½	108.0×48.3 4.250×1.900	300 2.07	51 2.00	172 6.77	88 3.46	85 3.35	85 3.35	1/2×75 M12X76
100×50 108.0×2	108.0×60.3 4.250×2.375	300 2.07	64 2.50	172 6.77	103.5 4.19	89 3.50	89 3.50	1/2×75 M12X76
100×15 4×½	114.3×21.3 4.500×0.825	300 2.07	38 1.50	178 7.01	77.5 3.05	82 3.23	82 3.23	1/2×75 M12X76
100×20 4×¾	114.3×26.9 4.500×1.050	300 2.07	38 1.50	178 7.01	77.5 3.05	82 3.23	82 3.23	1/2×75 M12X76
100×25 4×1	114.3×33.7 4.500×1.315	300 2.07	38 1.50	178 7.01	77.5 3.05	82 3.23	82 3.23	1/2×75 M12X76
100×32 4×1¼	114.3×42.4 4.500×1.660	300 2.07	51 2.00	178 7.01	88 3.46	89.5 3.53	89.5 3.53	1/2×75 M12X76
100×40 4×1½	114.3×48.3 4.500×1.900	300 2.07	51 2.00	178 7.01	88 3.46	89.5 3.53	89.5 3.53	1/2×75 M12X76
100×50 4×2	114.3×60.3 4.500×2.375	300 2.07	64 2.50	178 7.01	103.5 4.07	92 3.62	92 3.62	1/2×75 M12X76
125×25 133.0×1	133.0×33.7 5.250×1.315	300 2.07	38 1.50	203 7.99	77 3.03	98 3.86	98 3.86	5/8×85 M16X85
125×32 133.0×1.25	133.0×42.4 5.250×1.660	300 2.07	51 2.00	203 7.99	91 3.58	102 4.01	102 4.01	5/8×85 M16X85
125×40 133.0×1½	133.0×48.3 5.250×1.900	300 2.07	51 2.00	203 7.99	91 3.58	102 4.01	102 4.01	5/8×85 M16X85
125×50 133.0×2	133.0×60.3 5.250×2.375	300 2.07	64 2.50	203 7.99	110 4.33	105 4.13	105 4.13	5/8×85 M16X85
125×65 133.0×76.1	133.0×76.1 5.250×3.000	300 2.07	70 2.75	203 7.99	110 4.33	110 4.33	110 4.33	5/8×85 M16X85
125×25 139.7×1	139.7×33.7 5.500×1.315	300 2.07	38 1.50	210 8.27	77 3.03	100 3.94	100 3.94	5/8×85 M16X85
125×32 139.7×1¼	139.7×42.4 5.500×1.660	300 2.07	51 2.00	210 8.27	91 3.58	105 4.13	105 4.13	5/8×85 M16X85
125×40 139.7×1½	139.7×48.3 5.500×1.900	300 2.07	51 2.00	210 8.27	91 3.58	105 4.13	105 4.13	5/8×85 M16X85
125×50 139.7×2	139.7×60.3 5.500×2.375	300 2.07	64 2.50	210 8.27	110 4.33	108 4.25	108 4.25	5/8×85 M16X85
125×65 139.7×76.1	139.7×76.1 5.500×3.000	300 2.07	70 2.75	210 8.27	110 4.33	115 4.53	115 4.53	5/8×85 M16X85
150×25 159.0×1	159.0×33.7 6.250×1.315	300 2.07	38 1.50	227 8.94	77 3.03	110 4.33	110 4.33	5/8×85 M16X85

4JS

Light-duty
Mechanical Cross
Threaded Outlet

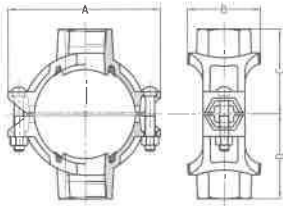

Nominal Size mm/in	Pipe O.D mm/in	Working Pressure PSI/MPa	Hole Dia mm/in +1.6,0/+0.063,0	Dimensions mm/in				Bolt Size mm/in
				A mm/in	B mm/in	C mm/in	D mm/in	
150×32 159.0×1¼	159.0×42.4 6.250×1.660	300 2.07	51 2.00	227 8.94	92.5 3.64	112 4.41	112 4.41	5/8×85 M16X85
150×40 159.0×1½	159.0×48.3 6.250×1.900	300 2.07	51 2.00	227 8.94	92.5 3.64	112 4.41	112 4.41	5/8×105 M16X108
150×50 159.0×2	159.0×60.3 6.250×2.375	300 2.07	64 2.50	227 8.94	110 4.33	116.5 4.59	116.5 4.59	5/8×105 M16X108
150×65 159.0×76.1	159.0×76.1 6.250×3.000	300 2.07	70 2.75	227 8.94	110 4.33	121.5 4.78	121.5 4.78	5/8×105 M16X108
150×80 159.0×3	159.0×88.9 6.250×3.500	300 2.07	89 3.50	227 8.94	130 5.12	123.5 4.86	123.5 4.86	5/8×105 M16X108
150×15 165.1×½	165.1×21.3 6.500×0.825	300 2.07	38 1.50	235 9.25	77 3.03	115 4.53	115 4.53	5/8×105 M16X108
125×20 165.1×¾	165.1×26.9 6.500×1.050	300 2.07	38 1.50	235 9.25	77 3.03	115 4.53	115 4.53	5/8×105 M16X108
150×25 165.1×1	165.1×33.7 6.500×1.315	300 2.07	38 1.50	235 9.25	77 3.03	115 4.53	115 4.53	5/8×105 M16X108
150×32 165.1×1¼	165.1×42.4 6.500×1.660	300 2.07	51 2.00	235 9.25	92.5 3.64	115 4.53	115 4.53	5/8×105 M16X108
150×40 165.1×1½	165.1×48.3 6.500×1.900	300 2.07	51 2.00	235 9.25	92.5 3.64	115 4.53	115 4.53	5/8×105 M16X108
150×50 165.1×2	165.1×60.3 6.500×2.375	300 2.07	64 2.50	235 9.25	110 4.33	120 4.72	120 4.72	5/8×105 M16X108
150×65 165.1×76.1	165.1×76.1 6.500×3.000	300 2.07	70 2.75	235 9.25	110 4.33	125 4.92	125 4.92	5/8×105 M16X108
150×80 165.1×3	165.1×88.9 6.500×3.500	300 2.07	89 3.50	235 9.25	130 5.12	125 4.92	125 4.92	5/8×105 M16X108
150×25 6×1	168.3×33.7 6.500×1.315	300 2.07	38 1.50	240 9.45	77 3.03	115 4.53	115 4.53	5/8×105 M16X108
150×32 6×1¼	168.3×42.4 6.500×1.660	300 2.07	51 2.00	240 9.45	92.5 3.64	115 4.53	115 4.53	5/8×105 M16X108
150×40 6×1½	168.3×48.3 6.500×1.900	300 2.07	51 2.00	240 9.45	92.5 3.64	115 4.53	115 4.53	5/8×105 M16X108
150×50 6×2	168.3×60.3 6.625×2.375	300 2.07	64 2.50	240 9.45	110 4.33	121 4.76	121 4.76	5/8×105 M16X108
150×65 6×2½	168.3×73.0 6.625×2.875	300 2.07	70 2.75	240 9.45	110 4.33	127 5.00	127 5.00	5/8×105 M16X108
150×80 6×3	168.3×88.9 6.625×3.500	300 2.07	89 3.50	240 9.45	130 5.12	127 5.00	127 5.00	5/8×105 M16X108
200×25 8×1	219.0×33.7 8.625×1.315	300 2.07	38 1.50	300 11.81	78 3.07	140 5.51	140 5.51	5/8×105 M16X108
200×32 8×1¼	219.1×42.4 8.625×1.660	300 2.07	51 2.00	300 11.81	93 3.66	140 5.51	140 5.51	5/8×105 M16X108
200×40 8×1½	219.1×48.3 8.625×1.900	300 2.07	51 2.00	300 11.81	93 3.66	143 5.63	143 5.63	5/8×105 M16X108
200×50 8×2	219.1×60.3 8.625×2.375	300 2.07	64 2.50	300 11.81	115 4.53	149 5.87	149 5.87	5/8×105 M16X108
200×65 8×2½	219.1×76.1 8.625×3.000	300 2.07	70 2.75	300 11.81	115 4.53	155 6.10	155 6.10	5/8×105 M16X108
200×80 8×3	219.1×88.9 8.625×3.500	300 2.07	89 3.50	300 11.81	133.5 5.25	165 6.10	165 6.10	5/8×105 M16X108
200×100 8×4	219.1×114.3 8.625×4.500	300 2.07	114 4.50	300 11.81	159.5 6.29	160 6.30	160 6.30	5/8×105 M16X108

230

Grooved Eccentric Reducer

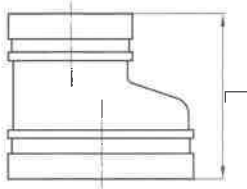

Nominal Size mm/in	Pipe O.D mm/in	Working Pressure PSI/MPa	Dimensions L mm/in	Certificate
40X32 1½X1¼	48.3X42.4 1.900X1.680	500 3.45	89 3.50	—
50X40 2X1½	60.3X48.3 2.375X1.900	500 3.45	89 3.50	—
80X50 3X2	88.9X60.3 3.500X2.375	500 3.45	89 3.50	UL FM
100X65 4X2½	108.0X76.1 4.250X3.000	500 3.45	102 4.00	UL FM
100X80 4X3	108.0X88.9 4.250X3.500	500 3.45	102 4.00	UL FM
100X50 4X2	114.3X60.3 4.500X2.000	500 3.45	102 4.00	UL FM
100X65 4X2½	114.3X76.1 4.500X3.000	300 2.07	102 4.00	UL FM
100X80 4X3	114.3X88.9 4.500X3.500	500 3.45	102 4.00	UL FM
125X100 5X4	139.7X114.3 5.500X4.500	300 2.07	127 5.00	UL FM
150X100 6X4	159.0X108.0 6.250X4.250	300 2.07	140 5.50	UL FM
150X100 6X4	159.0X114.3 6.250X4.500	300 2.07	140 5.50	UL FM
150X80 6X3	165.1X88.9 6.500X3.500	300 2.07	140 5.50	UL FM
150X100 6X4	165.1X114.3 6.500X4.500	300 2.07	140 5.50	UL FM
150X125 6X5	165.1X139.7 6.500X5.500	300 2.07	140 5.50	UL FM
150X80 6X3	168.3X88.9 6.625X3.500	300 2.07	140 5.50	UL FM
150X100 6X4	168.3X114.3 6.625X4.500	300 2.07	140 5.50	UL FM
150X125 6X5	168.3X139.7 6.625X5.500	300 2.07	140 5.50	UL FM
200X100 8X4	219.1X114.3 8.625X4.500	300 2.07	215 8.50	UL FM
200X150 8X6	219.1X165.1 8.625X6.500	300 2.07	215 8.50	—
200X150 8X6	219.1X168.3 8.625X6.625	300 2.07	215 8.50	—
250X200 10X8	273.0X219.1 10.750X8.625	300 2.07	215 8.50	UL FM
350X150 14X6	356.6X168.3 14.000X6.625	300 2.07	330 12.99	—
350X200 14X8	356.6X219.1 14.000X8.625	300 2.07	330 12.99	—
350X250 14X10	356.6X273.0 14.000X10.750	300 2.07	330 12.99	—
350X300 14X12	356.6X323.9 14.000X12.750	300 2.07	330 12.99	—
400X200 16X8	406.4X219.1 16.000X8.625	300 2.07	356 14.02	—
400X250 16X10	406.4X273.0 16.000X10.750	300 2.07	356 14.02	—
400X300 16X12	406.4X323.9 16.000X12.750	300 2.07	356 14.02	—
400X350 16X14	406.4X356.6 16.000X14.000	300 2.07	356 14.02	—
450X150 18X6	457.2X168.3 18.000X6.625	300 2.07	381 15.00	—
450X250 18X10	457.2X273.0 18.000X10.750	300 2.07	381 15.00	—
450X300 18X12	457.2X323.9 18.000X12.750	300 2.07	381 15.00	—
450X350 18X14	457.2X356.6 18.000X14.000	300 2.07	381 15.00	—
450X400 18X16	457.2X406.4 18.000X16.000	300 2.07	381 15.00	—

230

Grooved Eccentric Reducer

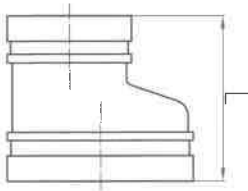

Nominal Size mm/in	Pipe O.D mm/in	Working Pressure PSI/MPa	Dimensions L mm/in	Certificate
500X300 20X12	508.0X323.9 20.000X12.750	300 2.07	508 20.00	—
500X350 20X14	508.0X355.6 20.000X14.000	300 2.07	508 20.00	—
500X400 20X16	508.0X406.4 20.000X16.000	300 2.07	508 20.00	—
500X450 20X18	508.0X457.2 20.000X18.000	300 2.07	508 20.00	—
600X400 24X16	609.6X406.4 24.000X16.000	300 2.07	508 20.00	—
600X450 24X18	609.6X457.2 24.000X18.000	300 2.07	508 20.00	—
600X500 24X20	609.6X508.0 24.000X20.000	300 2.07	508 20.00	—

Segmental sizes are made of carbon steel pipe or fabricated from wrought carbon steel. Contact manufacturer for details.

230N

Grooved Eccentric Reducer with Female Thread

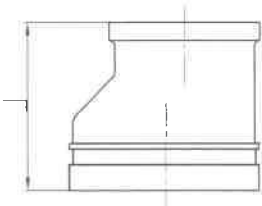

Nominal Size mm/in	Pipe O.D mm/in	Working Pressure PSI/MPa	Dimensions L mm/in	Certificate
100X85 4X2 1/2	114.3X76.1 4.500X3.000	300 2.07	102 4.00	UL FM
125X80 5X3	139.7X88.9 5.500X3.500	300 2.07	127 5.00	UL FM
150X80 6X3	165.1X88.9 6.500X3.500	300 2.07	140 5.50	UL FM

240

Grooved Concentric Reducer

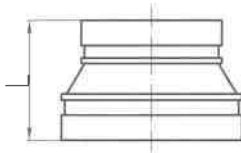

Nominal Size mm/in	Pipe O.D mm/in	Working Pressure PS/MPa	Dimensions L mm/in	Certificate
32X25 1 1/4 X1	42.4X33.7 1.660X1.315	500 3.45	64 2.50	UL FM VdS LPCB
40X25 1 1/2 X1	48.3X33.7 1.900X1.315	500 3.45	64 2.50	UL FM VdS LPCB
40X32 1 1/2 X1 1/4	48.3X42.4 1.900X1.660	500 3.45	64 2.50	UL FM VdS LPCB
50X25 2 X1	60.3X33.7 2.375X1.315	500 3.45	64 2.50	UL FM VdS LPCB
50X32 2 X1 1/4	60.3X42.4 2.375X1.660	500 3.45	64 2.50	UL FM VdS LPCB
50X40 2 X1 1/2	60.3X48.3 2.375X1.900	500 3.45	64 2.50	UL FM VdS LPCB
65X25 2 1/2 X1	73.0X33.7 2.875X1.315	500 3.45	64 2.50	UL FM
65X32 2 1/2 X1 1/4	73.0X42.4 2.875X1.660	500 3.45	64 2.50	UL FM
65X40 2 1/2 X1 1/2	73.0X48.3 2.875X1.900	500 3.45	64 2.50	UL FM
65X50 2 1/2 X2	73.0X60.3 2.875X2.375	500 3.45	64 2.50	UL FM
65X25 2 1/2 X1	76.1 X33.7 3.000X1.315	500 3.45	64 2.50	—
65X32 2 1/2 X1 1/4	76.1X42.4 3.000X1.660	500 3.45	64 2.50	UL FM VdS LPCB
65X40 2 1/2 X1 1/2	76.1X48.3 3.000X1.900	500 3.45	64 2.50	UL FM VdS LPCB
65X50 2 1/2 X2	76.1X60.3 3.000X2.375	500 3.45	64 2.50	UL FM VdS LPCB
80X25 3 X1	88.9X33.7 3.500X1.315	500 3.45	64 2.50	UL FM VdS
80X32 3 X1 1/4	88.9X42.4 3.500X1.660	500 3.45	64 2.50	UL FM
80X40 3 X1 1/2	88.9X48.3 3.500X1.900	500 3.45	64 2.50	UL FM VdS
80X50 3 X2	88.9X60.3 3.500X2.375	500 3.45	64 2.50	UL FM VdS LPCB
80X65 3 X2 1/2	88.9X73.0 3.500X2.875	500 3.45	64 2.50	UL FM
80X65 3 X2 1/2	88.9X76.1 3.500X3.000	500 3.45	64 2.50	UL FM VdS LPCB
100X50 4 X2	108.0X60.3 4.250X2.375	500 3.45	76 3.00	UL FM
100X65 4 X2 1/2	108.0X73.0 4.250X2.875	500 3.45	76 3.00	UL FM
100X65 4 X2 1/2	108.0X76.1 4.250X3.000	500 3.45	76 3.00	UL FM
100X80 4 X3	108.0X88.9 4.250X3.500	500 3.45	76 3.00	UL FM
100X32 4 X1 1/4	114.3X42.4 4.500X1.660	500 3.45	76 3.00	UL FM VdS
100X40 4 X1 1/2	114.3X48.3 4.500X1.900	500 3.45	76 3.00	UL FM VdS LPCB
100X50 4 X2	114.3X60.3 4.500X2.375	500 3.45	76 3.00	UL FM VdS LPCB
100X65 4 X2 1/2	114.3X73.0 4.500X2.875	500 3.45	76 3.00	UL FM
100X65 4 X2 1/2	114.3X76.1 4.500X3.000	500 3.45	76 3.00	UL FM VdS LPCB
100X80 4 X3	114.3X88.9 4.500X3.500	500 3.45	76 3.00	UL FM VdS LPCB
125X100 5 X4	133.0X108.0 5.250X4.250	500 3.45	89 3.50	UL FM
125X100 15 X4	133.0X114.3 5.250X4.500	500 3.45	89 3.50	UL FM
125X50 5 X2	139.7X60.3 5.500X2.375	500 3.45	89 3.50	UL FM
125X65 5 X2 1/2	139.7X76.1 5.500X3.000	500 3.45	89 3.50	UL FM VdS
125X80 5 X3	139.7X88.9 5.500X3.500	500 3.45	89 3.50	UL FM VdS

240

Grooved Concentric Reducer

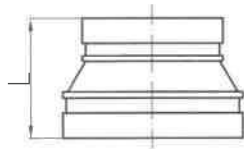

Nominal Size mm/in	Pipe O.D mm/in	Working Pressure PSI/MPa	Dimensions L mm/in	Certificate
125X100 5X4	139.7X114.3 5.500X4.500	500 3.45	89 3.50	UL FM VdS LPCB
125X65 5X2½	141.3X73.0 5.563X2.875	500 3.45	89 3.50	UL FM
125X80 5X3	141.3X88.9 5.563X3.500	500 3.45	89 3.50	UL FM
125X100 5X4	141.3X114.3 5.563X4.500	500 3.45	89 3.50	UL FM
150X50 6X2	159.0X60.3 6.250X2.375	500 3.45	102 4.00	UL FM
150X65 6X2½	159.0X76.1 6.250X3.000	500 3.45	102 4.00	UL FM
150X80 6X3	159.0X88.9 6.250X3.500	500 3.45	102 4.00	UL FM
150X100 6X4	159.0X108.0 6.250X4.250	500 3.45	102 4.00	UL FM
150X100 6X4	159.0X114.3 6.250X4.500	500 3.45	102 4.00	UL FM
150X125 6X5	159.0X133.0 6.250X5.250	500 3.45	102 4.00	UL FM
150X50 6X2	165.1X60.3 6.500X2.375	500 3.45	102 4.00	UL FM
150X65 6X2½	165.1X76.1 6.500X3.000	500 3.45	102 4.00	UL FM
150X80 6X3	165.1X88.9 6.500X3.500	500 3.45	102 4.00	UL FM LPCB
150X100 6X4	165.1X108.0 6.500X4.250	500 3.45	102 4.00	—
150X100 6X4	165.1X114.3 6.500X4.500	500 3.45	102 4.00	UL FM LPCB
150X125 6X5	165.1X139.7 6.500X5.500	500 3.45	102 4.00	UL FM LPCB
150X125 6X5	165.1X141.3 6.500X5.563	500 3.45	102 4.00	—
150X50 6X2	168.3X60.3 6.625X2.375	500 3.45	102 4.00	UL FM VdS
150X65 6X2½	168.3X73.0 6.625X2.875	500 3.45	102 4.00	UL FM
150X65 6X2½	168.3X76.1 6.625X3.000	500 3.45	102 4.00	UL FM VdS
150X80 6X3	168.3X88.9 6.625X3.500	500 3.45	102 4.00	UL FM VdS
150X100 6X4	168.3X114.3 6.625X4.500	500 3.45	102 4.00	UL FM VdS LPCB
150X125 6X5	168.3X139.7 6.625X5.500	500 3.45	102 4.00	UL FM VdS LPCB
150X125 6X5	168.3X141.3 6.625X5.563	500 3.45	102 4.00	UL FM
200X100 8X4	216.3X114.3 8.516X4.500	500 3.45	127 5.00	UL FM
200X150 8X6	216.3X165.1 8.516X6.500	500 3.45	127 5.00	UL FM
200X65 8X2½	219.1X73.0 8.625X2.875	500 3.45	127 5.00	UL FM
200X80 8X3	219.1X88.9 8.625X3.500	500 3.45	127 5.00	UL FM VdS LPCB
200X100 8X4	219.1X108.0 8.625X4.250	500 3.45	127 5.00	UL FM
200X100 8X4	219.1X114.3 8.625X4.500	500 3.45	127 5.00	UL FM VdS LPCB
200X125 8X5	219.1X139.7 8.625X5.500	500 3.45	127 5.00	UL FM VdS LPCB
200X125 8X5	219.1X141.3 8.625X5.563	500 3.45	127 5.00	UL FM
200X150 8X6	219.1X168.3 8.625X6.625	500 3.45	127 5.00	UL FM
200X150 8X6	219.1X165.1 8.625X6.500	500 3.45	127 5.00	UL FM
200X150 8X6	219.1X168.3 8.625X6.625	500 3.45	127 5.00	UL FM VdS LPCB

240

Grooved Concentric Reducer

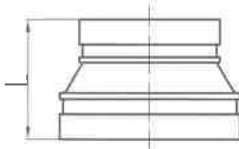

Nominal Size mm/in	Pipe O.D mm/in	Working Pressure PSI/MPa	Dimensions L mm/in	Certificate
250X150 10X6	273.0X159.0 10.750X6.250	500 3.45	152 6.00	UL FM
250X150 10X6	273.0X165.1 10.750X6.500	500 3.45	152 6.00	UL FM
250X150 10X6	273.0X168.3 10.750X6.625	500 3.45	152 6.00	UL FM VdS
250X200 10X8	273.0X219.1 10.750X8.625	500 3.45	152 6.00	UL FM VdS
300X200 12X8	323.9X219.1 12.750X8.625	500 3.45	178 7.00	UL FM VdS
300X250 12X10	323.9X273.0 12.750X10.750	500 3.45	178 7.00	UL FM VdS
350X125 14X5	377.0X133.0 14.850X5.250	300 2.07	127 5.00	---
350X150 14X6	377.0X159.0 14.850X6.250	300 2.07	127 5.00	---
350X150 14X6	355.6X168.3 14.000X6.625	300 2.07	330 12.99	---
350X200 14X8	355.6X219.1 14.000X8.625	300 2.07	203 7.99	---
350X250 14X10	355.6X273.0 14.000X10.750	300 2.07	203 7.99	---
350X300 14X12	355.6X323.9 14.000X12.750	300 2.07	203 7.99	---
400X200 16X8	406.4X219.1 16.000X8.625	300 2.07	229 9.00	---
400X250 16X10	406.4X273.0 16.000X10.750	300 2.07	229 9.00	---
400X300 16X12	406.4X323.9 16.000X12.750	300 2.07	229 9.00	---
400X350 16X14	406.4X355.6 16.000X14.000	300 2.07	229 9.00	---
450X150 18X6	457.2X168.3 18.000X6.625	300 2.07	381 15.00	---
450X250 18X10	457.2X273.0 18.000X10.750	300 2.07	381 15.00	---
450X300 18X12	457.2X323.9 18.000X12.750	300 2.07	241 9.50	---
450X350 18X14	457.2X355.6 18.000X14.000	300 2.07	241 9.50	---
450X400 18X16	457.2X406.4 18.000X16.000	300 2.07	241 9.50	---
500X200 20X8	530.0X219.1 20.866X8.625	300 2.07	135 5.31	---
500X300 20X12	508.0X323.9 20.000X12.750	300 2.07	254 10.00	---
500X350 20X14	508.0X355.6 20.000X14.000	300 2.07	254 10.00	---
500X400 20X16	508.0X406.4 20.000X16.000	300 2.07	254 10.00	---
500X450 20X18	508.0X457.2 20.000X18.000	300 2.07	254 10.00	---
600X400 24X16	609.6X406.4 24.000X16.000	300 2.07	305 12.00	---
600X450 24X18	609.6X457.2 24.000X18.000	300 2.07	305 12.00	---
600X500 24X20	609.6X508.0 24.000X20.000	300 2.07	305 12.00	---

Segmental sizes are made of carbon steel pipe or fabricated from wrought carbon steel. Contact manufacturer for details.

240N

Grooved Concentric Reducer with Female Thread

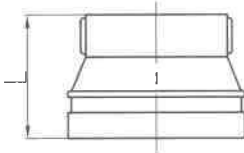

Nominal Size mm/in	Pipe O.D mm/in	Working Pressure PS/MPa	Dimensions L mm/in	Certificate
50X15 2X1/2	60.3X21.3 2.375X0.825	500 3.45	64 2.50	VdS
50X20 2X3/4	60.3X26.9 2.375X1.05	500 3.45	64 2.50	UL FM VdS LPCB
50X25 2X1	60.3X33.7 2.375X1.315	500 3.45	64 2.50	UL FM VdS LPCB
50X32 2X1 1/4	60.3X42.4 2.375X1.660	500 3.45	64 2.50	UL FM VdS LPCB
50X40 2X1 1/2	60.3X48.3 2.375X1.900	500 3.45	64 2.50	UL FM VdS LPCB
65X25 2 1/2 X1	73.0X33.7 2.875X1.315	500 3.45	64 2.50	UL FM
65X25 2 1/2 X1 1/4	73.0X42.4 2.875X1.660	500 3.45	64 2.50	UL FM
65X40 2 1/2 X1 1/2	73.0X48.3 2.875X1.900	500 3.45	64 2.50	UL FM
65X50 2 1/2 X2	73.0X60.3 2.875X2.375	500 3.45	64 2.50	UL FM
65X15 2 1/2 X1/2	76.1X21.3 3.000X0.825	500 3.45	64 2.50	UL FM VdS
65X20 2 1/2 X3/4	76.1X26.9 3.000X1.05	500 3.45	64 2.50	UL FM VdS
65X25 2 1/2 X1	76.1X33.7 3.000X1.315	500 3.45	64 2.50	UL FM VdS
65X32 2 1/2 X1 1/4	76.1X42.4 3.000X1.660	500 3.45	64 2.50	UL FM VdS LPCB
65X40 2 1/2 X1 1/2	76.1X48.3 3.000X1.900	500 3.45	64 2.50	FM VdS LPCB
65X50 2 1/2 X2	76.1X60.3 3.000X2.375	500 3.45	64 2.50	UL FM VdS LPCB
80X15 3X1/2	88.9X21.3 3.500X0.825	500 3.45	64 2.50	VdS
80X20 3X3/4	88.9X26.9 3.500X1.05	500 3.45	64 2.50	UL FM VdS
80X25 3X1	88.9X33.7 3.500X1.315	500 3.45	64 2.50	UL FM VdS
80X32 3X1 1/4	88.9X42.4 3.500X1.660	500 3.45	64 2.50	VdS
80X40 3X1 1/2	88.9X48.3 3.500X1.900	500 3.45	64 2.50	UL FM VdS
80X50 3X2	88.9X60.3 3.500X2.375	500 3.45	64 2.50	UL FM VdS LPCB
80X65 3X2 1/2	88.9X73.0 3.500X2.875	500 3.45	64 2.50	UL FM
80X65 3X2 1/2	88.9X76.1 3.500X3.000	500 3.45	64 2.50	UL FM VdS LPCB
100X25 4X1	108.0X33.7 4.250X1.315	500 3.45	76 3.00	UL FM
100X32 4X1 1/4	108.0X42.4 4.250X1.660	500 3.45	76 3.00	UL FM
100X40 4X1 1/2	108.0X48.3 4.250X1.900	500 3.45	76 3.00	UL FM
100X50 4X2	108.0X60.3 4.250X2.375	500 3.45	76 3.00	UL FM
100X65 4X2 1/2	108.0X76.1 4.250X3.000	500 3.45	76 3.00	UL FM
100X80 4X3	108.0X88.9 4.250X3.500	500 3.45	76 3.00	UL FM
100X15 4X1/2	114.3X21.3 4.500X0.825	500 3.45	76 3.00	UL FM VdS
100X20 4X3/4	114.3X26.9 4.500X1.05	500 3.45	76 3.00	UL FM VdS
100X25 4X1	114.3X33.7 4.500X1.315	500 3.45	76 3.00	UL FM VdS
100X32 4X1 1/4	114.3X42.4 4.500X1.660	500 3.45	76 3.00	UL FM VdS
100X40 4X1 1/2	114.3X48.3 4.500X1.900	500 3.45	76 3.00	UL FM VdS LPCB
100X50 4X2	114.3X60.3 4.500X2.375	500 3.45	76 3.00	UL FM VdS LPCB
100X65 4X2 1/2	114.3X73.0 4.500X2.875	500 3.45	76 3.00	UL FM
100X65 4X2 1/2	114.3X76.1 4.500X3.000	500 3.45	76 3.00	UL FM VdS LPCB
100X80 4X3	114.3X88.9 4.500X3.500	500 3.45	76 3.00	UL FM VdS LPCB
125X40 5X1 1/2	133.0X48.3 5.250X1.900	500 3.45	89 3.50	UL FM

240N

Grooved Concentric Reducer with Female Thread

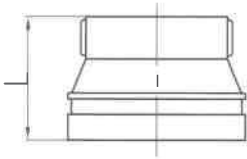

Nominal Size mm/in	Pipe O.D mm/in	Working Pressure PSI/MPa	Dimensions L mm/in	Certificate
125X40 5X2	133.0X60.3 5.250X2.375	500 3.45	89 3.50	—
125X65 5X2½	133.0X76.1 5.250X3.000	600 3.45	89 3.50	UL FM
125X85 5X3	133.0X88.9 5.250X3.500	500 3.45	89 3.50	—
125X25 5X1	139.7X33.7 5.500X1.315	500 3.45	89 3.50	UL FM VdS
125X32 5X1¼	139.7X42.4 5.500X1.660	500 3.45	89 3.50	UL FM VdS
125X40 5X1½	139.7X48.3 5.500X1.900	500 3.45	89 3.50	UL FM VdS
125X50 5X2	139.7X60.3 5.500X2.375	500 3.45	89 3.50	UL FM VdS
125X65 5X2½	139.7X76.1 5.500X3.000	500 3.45	89 3.50	UL FM VdS
125X80 5X3	139.7X88.9 5.500X3.500	500 3.45	89 3.50	UL FM VdS
125X100 5X4	139.7X114.3 5.500X4.500	500 3.45	89 3.50	UL FM VdS LPCB
125X100 5X4	141.3X114.3 5.563X4.500	500 3.45	89 3.50	UL FM
150X20 6X3/4	159.0X26.9 6.250X1.05	500 3.45	102 4.00	UL FM
150X25 6X1	159.0X33.7 6.250X1.315	500 3.45	102 4.00	UL FM
150X32 6X1¼	159.0X42.4 6.250X1.660	500 3.45	102 4.00	UL FM
150X40 6X1½	159.0X48.3 6.250X1.900	500 3.45	102 4.00	UL FM
150X50 6X2	159.0X60.3 6.250X2.375	500 3.45	102 4.00	UL FM
150X65 6X2½	159.0X76.1 6.250X3.000	500 3.45	102 4.00	UL FM
150X80 6X3	159.0X88.9 6.250X3.500	500 3.45	102 4.00	UL FM
150X100 6X4	159.0X114.3 6.250X4.500	500 3.45	102 4.00	UL FM
150X15 6X1/2	165.1X21.3 6.500X0.825	500 3.45	102 4.00	UL FM
150X20 6X3/4	165.1X26.9 6.500X1.05	500 3.45	102 4.00	UL FM
150X25 6X1	165.1X33.7 6.500X1.315	500 3.45	102 4.00	UL FM
150X32 6X1¼	165.1X42.4 6.500X1.660	500 3.45	102 4.00	UL FM
150X40 6X1½	165.1X48.3 6.500X1.900	500 3.45	102 4.00	UL FM
150X50 6X2	165.1X60.3 6.500X2.375	500 3.45	102 4.00	UL FM
150X65 6X2½	165.1X76.1 6.500X3.000	500 3.45	102 4.00	UL FM
150X80 6X3	165.1X88.9 6.500X3.500	500 3.45	102 4.00	UL FM LPCB
150X100 6X4	165.1X114.3 6.500X4.500	500 3.45	102 4.00	UL FM
150X25 6X1	168.3X33.7 6.625X1.315	500 3.45	102 4.00	UL FM
150X50 6X2	168.3X60.3 6.625X2.375	500 3.45	102 4.00	UL FM VdS
200X40 8X1½	219.1X48.3 8.625X1.900	500 3.45	127 5.00	UL FM
200X50 8X2	219.1X60.3 8.625X2.375	500 3.45	127 5.00	UL FM VdS
200X65 8X2½	219.1X76.1 8.625X3.000	500 3.45	127 5.00	UL FM VdS
200X80 8X3	219.1X88.9 8.625X3.500	500 3.45	127 5.00	UL FM VdS LPCB
200X100 8X4	219.1X114.3 8.625X4.500	500 3.45	127 5.00	UL FM

240W

Grooved Concentric Reducer with Male Thread



Nominal Size mm/in	Pipe O.D mm/in	Working Pressure PSI/MPa	Dimensions L mm/in	Certificate
65X50 2½X2	73.0X60.3 2.875X2.375	500 3.45	64 2.50	UL FM
65X50 2½X2	76.1X60.3 3.000X2.375	500 3.45	64 2.50	UL FM
80X25 3X1	88.9X33.7 3.500X1.315	500 3.45	64 2.50	UL FM
100X50 4X2	114.3X60.3 4.500X2.375	500 3.45	76 3.00	UL FM

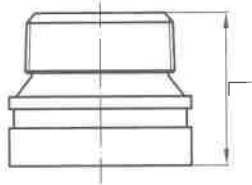

300

Cap

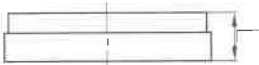

Nominal Size mm/in	Pipe O.D mm/in	Working Pressure PSI/MPa	Dimensions L mm/in	Certificate
25	33.7	500	22.1	UL FM Vds LPCB
1	1.315	3.45	0.87	
32	42.4	500	23.5	UL FM Vds LPCB
1¼	1.660	3.45	0.93	
40	48.3	500	23.5	UL FM Vds LPCB
1½	1.900	3.45	0.93	
50	60.3	500	23.5	UL FM Vds LPCB
2	2.375	3.45	0.93	
65	73.0	500	23.5	UL FM
2½	2.875	3.45	0.93	
65	76.1	500	24.5	UL FM Vds LPCB
2½	3.000	3.45	0.96	
80	88.9	500	24	UL FM Vds LPCB
3	3.500	3.45	0.94	
100	108.0	500	27	UL FM
4	4.250	3.45	1.06	
100	114.3	500	27	UL FM Vds LPCB
4	4.500	3.45	1.06	
25	133.0	500	25.5	UL FM
5	5.250	3.45	1.00	
125	139.7	500	25.5	UL FM Vds LPCB
5	5.500	3.45	1.00	
125	141.3	500	25.5	UL FM
5	5.583	3.45	1.00	
150	159.0	500	27	UL FM
6	6.250	3.45	1.06	
150	165.1	500	27	UL FM LPCB
6	6.500	3.45	1.06	
150	168.3	500	24.5	UL FM Vds LPCB
6	6.625	3.45	0.97	
200	216.3	500	30	UL FM
8	8.516	3.45	1.18	
200	219.1	500	30	UL FM Vds LPCB
8	8.625	3.45	1.18	
250	273.0	500	32	UL FM Vds LPCB
10	10.750	3.45	1.26	
300	323.9	500	32	UL FM Vds
12	12.750	3.45	1.26	
350	355.6	300	165	—
14	14.000	2.07	6.50	
400	406.4	300	178	—
16	16.000	2.07	7.00	
450	457.2	300	203	—
18	18.000	2.07	8.00	
500	508.0	300	229	—
20	20.000	2.07	9.00	
600	609.6	300	267	—
24	24.000	2.07	10.50	

Segmental sizes are made of carbon steel pipe or fabricated from wrought carbon steel. Contact manufacturer for details.

300

Cap with Concentric Hole

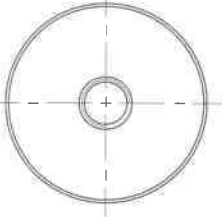
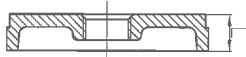

Nominal Size mm/in	Pipe O.D mm/in	Working Pressure PSI/MPa	Dimensions L mm/in	Certificate
50X25	60.3X33.7	500	23.5	—
2X1	2.375X1.315	3.45	0.93	—
65X25	76.1X33.7	500	24.5	—
2½×1	3.000X1.315	3.45	0.96	—
65×40	76.1×48.3	500	23.5	—
2½×1½	3.000×1.900	3.45	0.925	UL FM
65X50	76.1X60.3	500	24	—
2½×2	3.000X2.375	3.45	0.94	—
80X15	88.9X21.3	500	25.4	—
3X1/2	3.500X0.825	3.45	1.00	UL FM
80X25	88.9X33.7	500	24	—
3X1	3.500X1.315	3.45	0.94	UL FM
80X40	88.9X48.3	500	23.5	—
3X1½	3.500X1.900	3.45	0.925	UL FM
80×50	88.9×60.3	500	23.5	—
3×2	3.500×2.375	3.45	0.925	UL FM
100×15	114.3×21.3	500	27.0	—
4×1/2	4.500×0.825	3.45	1.08	UL FM
100×25	114.3×33.7	500	27.0	—
4×1	4.500×1.315	3.45	1.06	UL FM
100X40	114.3X48.3	500	25.4	—
4X1½	4.500X1.900	3.45	1.00	UL FM
100×50	114.3×60.3	500	25.4	—
4×2	4.500×2.375	3.45	1.00	—
125×50	139.7×60.3	500	27	—
5×2	5.500×2.375	3.45	1.06	UL FM
150×15	165.1×21.3	500	27	—
6×1/2	6.500×0.825	3.45	1.06	UL FM
150×25	165.1×33.7	500	27	—
6×1	6.500×1.315	3.45	1.06	UL FM
150×50	165.1×60.3	500	27	—
6×2	6.500×2.375	3.45	1.06	UL FM
150X40	168.3X48.3	500	27	—
6X1½	6.625X1.900	3.45	1.06	—
150×50	168.3×60.3	500	27	—
6×2	6.625×2.375	3.45	1.06	—
200X25	219.1X33.7	500	30	—
8X1	8.625X1.315	3.45	1.18	—

300PX

Cap with Eccentric Hole

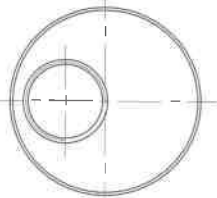

Nominal Size mm/in	Pipe O.D mm/in	Working Pressure PSI/MPa	Dimensions L mm/in	Certificate
65X25	76.1X33.7	500	23.5	—
2½X1	3.000X1.315	3.45	0.925	—
65X40	76.1X48.3	500	23.5	—
2½X1½	3.000X1.900	3.45	0.925	—
80X25	88.9X33.7	500	23.5	—
3X1	3.500X1.315	3.45	0.925	—
80X40	88.9X48.3	500	23.5	—
3X1½	3.500X1.900	3.45	0.925	UL FM
80×50	88.9×60.3	500	23.5	—
3×2	3.500×2.375	3.45	0.925	UL FM
100X25	114.3X33.7	500	27	—
4X1	4.500X1.315	3.45	1.06	—
100X40	114.3X48.3	500	25.4	—
4X1½	4.500X1.900	3.45	1.00	UL FM
100×50	114.3×60.3	500	25.4	—
4×2	4.500×2.375	3.45	1.00	UL FM
125×40	139.7×48.3	500	25.4	—
5×1½	5.500×1.900	3.45	1.00	UL FM
125×50	139.7×60.3	500	25.4	—
5×2	5.500×2.375	3.45	1.00	UL FM
150×40	165.1×48.3	500	25.4	—
6×1½	6.500×1.900	3.45	1.00	UL FM
150×40	168.3×48.3	500	25.4	—
6×1½	6.625×1.900	3.45	1.00	UL FM
150×50	168.3×60.3	500	25.4	—
6×2	6.625×2.375	3.45	1.00	UL FM
200×40	219.1×48.3	500	30.2	—
8×1½	8.625×1.900	3.45	1.19	UL FM
200×50	219.1×60.3	500	30.2	—
8×2	8.625×2.375	3.45	1.19	UL FM

321 PN16 Grooved Flange

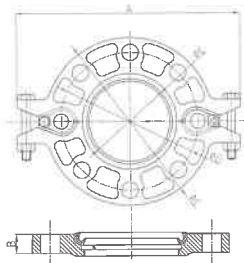

Nominal Size mm/in	Pipe O.D mm/in	Working Pressure PSI/MPa	Dimensions					Bolt/Nut		Certificate
			A mm/in	B mm/in	C mm/in	D mm/in	E mm/in	No.-SIZE mm		
40 1½	48.3 1.900	300 2.07	195 7.68	18.5 0.73	150 5.90	110 4.33	45.4 1.78	2-M10X50	4-M16	UL FM VdS
50 2	60.3 2.375	300 2.07	220 8.66	18.5 0.73	165 6.50	125 4.92	57.5 2.26	2-M10X50	4-M16	UL FM VdS
65 2½	76.1 3.000	300 2.07	235 9.25	18.5 0.73	185 7.28	145 5.71	72.7 2.86	2-M10X50	4-M16	UL FM VdS
80 3	88.9 3.500	300 2.07	255 10.04	18.5 0.73	195 7.68	160 6.30	85.5 3.37	2-M10X50	8-M16	UL FM VdS
100 4	108.0 4.250	300 2.07	279 10.98	18.5 0.73	220 8.66	180 7.09	104.5 4.11	2-M10X50	8-M16	UL FM
100 4	114.3 4.500	300 2.07	279 10.98	18.5 0.73	224 8.82	180 7.09	110.5 4.35	2-M10X50	8-M16	UL FM VdS
125 5	133.0 5.250	300 2.07	312 12.28	21.5 0.85	250 9.84	210 8.27	129.2 5.08	2-M12X65	8-M16	UL FM
125 5	139.7 5.500	300 2.07	320 12.60	23 0.91	250 9.84	210 8.27	135.5 5.33	2-M12X65	8-M16	UL FM
150 6	159.0 6.25	300 2.07	346 13.62	21.5 0.85	280 11.00	240 9.45	154.8 6.10	2-M12X65	8-M20	UL FM
150 6	165.1 6.500	300 2.07	346 13.62	21.5 0.85	280 11.00	240 9.45	160.8 6.33	2-M12X65	8-M20	UL FM
150 6	168.3 6.625	300 2.07	346 13.62	24 0.94	280 11.00	240 9.45	164.3 6.47	2-M12X65	8-M20	UL FM
200 8	219.1 8.625	300 2.07	414.3 16.31	30 1.18	340 13.39	295 11.61	214.9 8.46	2-3/8X70 2-M10X70	12-M20	UL FM VdS
250 10	273.0 10.750	300 2.07	480 18.90	25.5 1.00	405 15.94	355 13.98	268.9 10.59	2-3/8X70 2-M10X70	12-M24	UL FM VdS
300 12	323.9 12.750	300 2.07	530.5 20.88	25.5 1.00	460 18.11	410 16.14	318.9 12.56	2-3/8X70 2-M10X70	12-M24	UL FM
350 14	355.6 14.000	300 2.07	580 22.83	30 1.18	520 20.47	470 18.50	350.6 13.80	—	16-M24	—
400 16	406.4 16.000	300 2.07	630 24.80	32 1.26	580 22.83	525 20.67	401.5 15.81	—	16-M27	—
450 18	457.2 18.000	300 2.07	693 27.28	36 1.42	640 25.20	585 23.03	452.2 17.80	—	20-M27	—
500 20	508.0 20.000	300 2.07	770 30.31	36 1.42	715 28.15	650 25.59	503 19.80	—	20-M30	—
600 24	609.6 24.000	300 2.07	895 35.24	40 1.57	840 33.07	770 30.31	601.6 23.69	—	20-M33	—

321H PN25 Grooved Flange

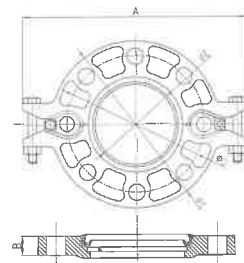

Nominal Size mm/in	Pipe O.D mm/in	Working Pressure PSI/MPa	Dimensions					Bolt/Nut		Certificate
			A mm/in	B mm/in	C mm/in	D mm/in	E mm/in	No.-SIZE mm		
100 108.0	108.0 4.250	362 2.5	290 11.41	21.5 0.85	230 9.06	190 7.48	104.5 4.11	2-M10X50	8-M20	UL FM
150 165.1	165.1 6.500	362 2.5	365 14.37	21.5 0.85	300 11.80	250 9.84	160.8 6.33	2-M12X65	8-M24	UL FM

321A

ANSI 125/150

Grooved Flange

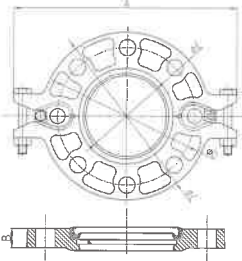

Nominal Size mm/in	Pipe O.D mm/in	Working Pressure PSI/MPa	Dimensions					Bolt/Nut		Certificate
			A mm/in	B mm/in	C mm/in	D mm/in	E mm/in	No. SIZE mm		
50	60.3	300	206	19	152	121	57.5	2-M10X50	4-5/8	UL FM
2	2.375	2.07	8.11	0.75	5.98	4.76	2.26			
65	73.0	300	230	19	178	140	69.8	2-M10X50	4-5/8	UL FM
2½	2.875	2.07	9.05	0.75	7.00	5.51	2.74			
65	76.1	300	230	19	178	140	72.7	2-M10X50	4-5/8	—
2½	3.000	2.07	9.05	0.75	7.00	5.51	2.86			
80	88.9	300	246	19	191	152	85.5	2-M10X50	4-5/8	UL FM
3	3.500	2.07	9.68	0.75	7.52	5.98	3.37			
100	114.3	300	280	19	229	191	110.5	2-M12X55	8-5/8	UL FM
4	4.500	2.07	11.02	0.75	9.00	7.52	4.35			
125	141.3	300	320	22	254	216	137.4	2-M12X65	8-3/4	UL FM
5	5.563	2.07	12.60	0.87	10.00	8.50	5.41			
150	168.3	300	346	24	280	241.3	164.3	2-M12X65	8-3/4	UL FM
6	6.625	2.07	13.62	0.94	11.00	9.50	6.47			
200	219.1	300	414.3	30	341.4	298.5	214.9	2-3/8X70	8-3/4	UL FM
8	8.625	2.07	16.31	1.18	13.44	11.75	8.46			
250	273.0	300	481.2	30.3	405.6	361.95	268.9	2-3/8X70	12-7/8	UL FM
10	10.750	2.07	18.94	1.19	15.97	14.25	10.59			
300	323.9	300	553.3	30.4	482.6	431.8	318.9	2-3/8X70	12-7/8	UL FM
12	12.750	2.07	21.78	1.20	19.00	17.00	12.56			
350	355.6	300	590	37	535	476.3	350.6	—	12-1	—
14	14.000	2.0	23.22	1.44	21.00	18.75	13.80			
400	406.4	300	650	37	595	539.8	401.5	—	16-1	—
16	16.000	2.0	25.59	1.44	23.50	21.25	15.81			
450	457.2	300	690	40	635	577.8	452.2	—	16-11/8	—
18	18.000	2.0	27.17	1.56	25.80	22.75	17.80			
500	508.0	300	765	43	700	635	503	—	20-11/8	—
20	20.000	2.0	30.12	1.69	27.50	25.00	19.80			
600	609.6	300	875	49	815	749.3	601.6	—	20-11/4	—
24	24.000	2.0	34.45	1.94	32.00	29.50	23.69			

321E

BS TABLE 'E'

Grooved Flange

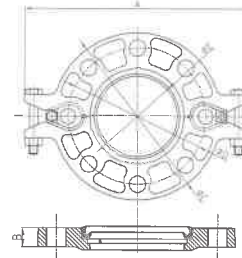

Nominal Size mm/in	Pipe O.D mm/in	Working Pressure PSI/MPa	Dimensions					Bolt/Nut		Certificate
			A mm/in	B mm/in	C mm/in	D mm/in	E mm/in	No. SIZE mm		
50	60.3	300	211	18.5	150	114	57.5	2-M10X50	4-M16	—
2	2.375	2.07	8.31	0.73	5.91	4.49	2.26			
80	88.9	300	241	18.5	185	146	85.5	2-M10X50	4-M16	—
3	3.500	2.07	9.49	0.73	7.28	5.75	3.37			
100	114.3	300	270	18.5	216	178	110.5	2-M10X50	8-M16	—
4	4.500	2.07	10.63	0.73	8.50	7.00	4.35			
150	165.1	300	346	21.5	280	235	160.8	2-M12X65	8-M20	—
6	6.500	2.07	13.62	0.85	11.02	9.25	6.33			
200	219.1	300	408	24	335	292	214.9	2-3/8X70	8-M20	—
8	8.625	2.07	16.06	0.94	13.19	11.50	8.46			
250	273.0	200	480	25.5	406	356	268.9	—	12-3/4	—
10	10.750	1.4	18.90	1.00	16.00	14.00	10.59			
300	323.9	200	530.5	25.5	457	406	318.9	—	12-7/8	—
12	12.750	1.4	20.88	1.00	18.00	16.00	12.56			
350	355.6	200	580	32	527	470	350.6	—	12-7/8	—
14	14.000	1.4	22.83	1.26	20.75	18.50	13.80			
400	406.4	200	630	32	578	521	401.5	—	12-7/8	—
16	16.000	1.4	24.80	1.26	22.76	20.51	15.81			
450	457.2	200	693	36	641	584	452.2	—	16-7/8	—
18	18.000	1.4	27.28	1.42	25.24	23.00	17.80			
500	508.0	200	770	38	705	641	503	—	16-7/8	—
20	20.000	1.4	30.31	1.50	27.76	25.24	19.80			
600	609.6	200	880	42	826	756	601.6	—	16-11/8	—
24	24.000	1.4	34.65	1.65	32.52	29.76	23.69			

321G PN16

Adaptor Flange

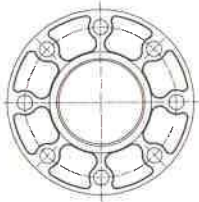
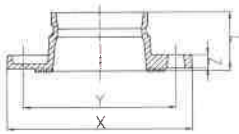

Nominal Size mm/in	Pipe O.D mm/in	Working Pressure PSI/MPa	Dimensions				Bolt/Nut No.-SIZE mm	Certificate
			L mm/in	X mm/in	Y mm/in	Z mm/in		
25	33.7	300	60.5	115	85	16	4-M12	UL FM VdS LPCB
1	1.327	2.0	2.382	4.53	3.35	0.63		
32	42.4	300	60.5	140	100	16	4-M16	UL FM VdS LPCB
1 1/4	1.669	2.0	2.382	5.51	3.94	0.63		
40	48.3	300	60.5	150	110	16	4-M16	UL FM VdS LPCB
1 1/2	1.902	2.0	2.382	5.91	4.33	0.63		
50	60.3	500	65	165	125	16	4-M16	UL FM VdS LPCB
2	2.375	3.45	2.559	6.50	4.92	0.63		
65	76.1	500	65	185	145	16	4-M16	UL FM VdS LPCB
76.1	3.000	3.45	2.559	7.28	5.70	0.63		
80	88.9	500	65	200	160	16	8-M16	UL FM VdS LPCB
3	3.500	3.45	2.559	7.87	6.30	0.63		
100	108.0	300	70	220	180	16	8-M16	UL FM
108.0	4.250	2.0	2.756	8.66	7.09	0.63		
100	114.3	300	70	220	180	16	8-M16	UL FM VdS LPCB
4	4.500	2.0	2.756	8.66	7.09	0.63		
125	133	300	70	250	210	18	8-M16	UL FM
133.0	5.250	2.0	2.756	9.84	8.27	0.71		
125	139.7	300	70	250	210	18	8-M16	UL FM VdS LPCB
139.7	5.500	2.0	2.756	9.84	8.27	0.71		
150	159.0	500	70	285	240	18	8-M20	UL FM
159.1	6.250	3.45	2.756	11.22	9.45	0.71		
150	165.1	500	70	285	240	18	8-M20	UL FM LPCB
165.1	6.500	3.45	2.756	11.22	9.45	0.71		
150	168.3	500	70	285	240	18	8-M20	UL FM VdS LPCB
6	6.625	3.45	2.756	11.22	9.45	0.71		
200	219.1	300	80	340	295	19	12-M20	UL FM VdS LPCB
8	8.625	2.0	3.150	13.39	11.61	0.75		
250	273.0	300	85	405	355	21	12-M24	UL FM VdS
10	10.750	2.0	3.346	15.94	13.98	0.83		
300	323.9	225	90	460	410	24	12-M24	UL FM VdS
12	12.750	1.6	3.543	18.11	16.14	0.94		
350	377.0	225	100	520	470	25	16-M24	UL FM
14	14.843	1.6	3.937	20.47	18.50	1.00		
400	426.0	225	110	580	525	27	16-M27	UL FM
16	16.772	1.6	4.331	22.83	20.87	1.06		
450	480	225	115	640	585	20	20-M27	—
18	18.897	1.6	4.528	25.196	23.03	0.787		

321GH PN25

Adaptor Flange

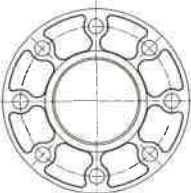
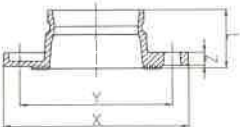

Nominal Size mm/in	Pipe O.D mm/in	Working Pressure PSI/MPa	Dimensions				Bolt/Nut No.-SIZE mm	Certificate
			L mm/in	X mm/in	Y mm/in	Z mm/in		
100	108.0	362	70	230	190	18	8-M20	UL FM
108.0	4.250	2.5	2.756	9.05	7.48	0.71		
100	114.3	362	70	235	190	16	8-M20	UL FM
4	4.500	2.5	2.756	9.25	7.48	0.63		
150	159.0	362	70	300	250	20	8-M24	UL FM
159.0	6.250	2.5	2.756	11.80	9.85	0.79		
150	165.1	362	70	300	250	18	8-M24	UL FM
165.1	6.500	2.5	2.756	11.80	9.84	0.71		
200	219.1	362	80	360	310	19	12-M24	UL FM
8	8.625	2.5	3.150	14.17	12.20	0.75		
250	273.0	362	85	425	370	22	12-M27	—
10	10.75	2.5	3.346	16.73	14.57	0.87		
300	323.9	362	88	485	430	23.5	16-M27	—
12	12.750	2.5	3.46	19.09	16.93	0.93		
350	355.6	362	100	555	490	26	16-M30	—
14	14.000	2.5	3.94	21.85	19.29	1.02		
400	408.4	362	110	620	550	28	16-M33	—
16	16.000	2.5	4.33	24.41	21.65	1.10		

321GA

ANSI 125/150

Adaptor Flange
Class 125/150

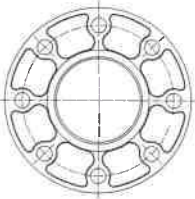
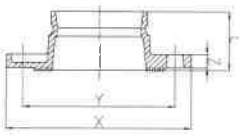

Nominal Size mm/in	Pipe O.D. mm/in	Working Pressure PSI/MPa	Dimensions				Bolt/Nut No.-SIZE mm	Certificate
			L mm/in	X mm/in	Y mm/in	Z mm/in		
50 2	60.3 2.375	300 2.07	65 2.559	152 6.0	120.5 4.74	16 0.63	4-5/8	UL FM
65 2½	73.0 2.875	300 2.07	65 2.559	185 7.28	139.7 5.50	16 0.63	4-5/8	UL FM
80 3	88.9 3.500	300 2.07	65 2.559	200 7.87	152.4 6.00	16 0.63	8-5/8	UL FM
100 4	114.3 4.500	300 2.07	70 2.756	229 9.01	190.5 7.50	16 0.63	8-5/8	UL FM
150 6	168.3 6.625	300 2.07	70 2.756	282 11.10	241.3 9.50	18 0.71	8-3/4	UL FM
200 8	219.1 8.625	300 2.07	75 2.953	340 13.39	298.5 11.75	19 0.75	8-3/4	UL FM
250 10	273.0 10.75	300 2.07	85 3.35	406 15.98	362 14.25	21 0.826	12-7/8	UL FM
350 14	355.6 12.750	300 2.0	127 5.00	535 21.00	476.3 18.75	37 1.44	12-1	—
400 16	406.4 16.000	300 2.0	127 5.00	595 23.50	539.8 21.25	37 1.44	16-1	—
450 18	457.2 18.000	300 2.0	140 5.50	642 25.28	577.8 22.75	40 1.56	16-11/8	—
500 20	508.0 20.000	300 2.0	152 6.00	700 27.50	635 25.00	43 1.69	20-11/8	—
600 24	609.6 24.000	300 2.0	152 6.00	815 32.00	749.3 29.50	49 1.94	20-11/4	—

321GL

PN10

Adaptor Flange

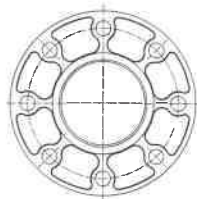
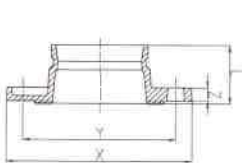

Nominal Size mm/in	Pipe O.D. mm/in	Working Pressure PSI/MPa	Dimensions				Bolt/Nut No.-SIZE mm	Certificate
			L mm/in	X mm/in	Y mm/in	Z mm/in		
200 8	219.1 8.625	145 1.0	75 2.95	340 13.39	295 11.81	19 0.75	8-M20	UL FM
250 10	273.0 10.750	145 1.0	85 3.346	405 15.94	360 13.78	21 0.83	12-M20	UL FM
300 12	323.9 12.750	145 1.0	90 3.543	460 18.11	400 15.75	24 0.94	12-M20	UL FM

321G BS.TABLE 'E'

Adaptor Flange

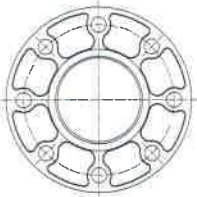
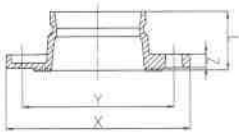

Nominal Size mm/in	Pipe O.D mm/in	Working Pressure PS/MPa	Dimensions				Bolt/Nut No. -SIZE mm	Certificate
			L mm/in	X mm/in	Y mm/in	Z mm/in		
50 2	60.3 2.375	225 1.6	65 2.56	152 5.98	114 4.49	16 0.63	4-M16	—
65 76.1	76.1 3.000	225 1.6	70 2.756	165 6.50	127 5.00	16 0.63	4-M16	—
80 3	88.9 3.500	225 1.6	70 2.756	184 7.24	146 5.75	16 0.63	4-M16	—
100 4	114.3 4.500	225 1.6	70 2.756	216 8.50	178 7.00	16 0.63	8-M16	FM
150 165.1	165.1 6.500	225 1.6	70 2.756	280 11.02	235 9.25	21 0.71	8-M20	FM
200 8	219.1 8.625	225 1.6	102 4.02	337 13.27	292 11.50	19 0.75	8-M20	—
250 10	273.0 10.75	225 1.6	85 3.35	405 15.94	356 14.02	25 0.98	12-M20	—
300 12	323.9 10.750	200 1.4	102 4.02	457 18.00	408 16.00	25.5 1.00	12-7/8	—
350 14	355.6 12.750	200 1.4	127 5.00	527 20.75	470 18.50	32 1.26	12-7/8	—
400 16	406.4 16.000	200 1.4	127 5.00	578 22.76	521 20.51	32 1.26	12-7/8	—
450 18	457.2 18.000	200 1.4	140 5.50	641 25.24	584 23.00	36 1.42	16-7/8	—

321GJ JIS 10K

Adaptor Flange

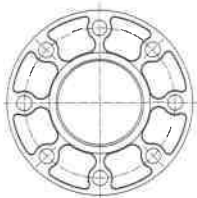
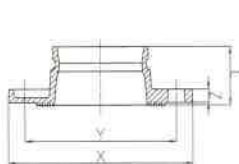

Nominal Size mm/in	Pipe O.D mm/in	Working Pressure PS/MPa	Dimensions				Bolt/Nut No. -SIZE mm	Certificate
			L mm/in	X mm/in	Y mm/in	Z mm/in		
65 2½	76.3 3.00	145 1.0	65 2.559	175 6.89	140 5.51	18 0.71	4-M16	—
80 3	89.1 3.50	145 1.0	65 2.559	185 7.28	150 5.91	18 0.71	8-M16	—
100 4	114.3 4.50	145 1.0	70 2.756	210 8.27	175 6.89	18 0.71	8-M16	—
125 5	139.8 5.50	145 1.0	70 2.756	250 9.84	210 8.27	20 0.79	8-M20	—
150 6	165.2 6.50	145 1.0	70 2.756	280 11.02	240 9.45	20 0.79	8-M20	—

321GJ JIS 16K

Adaptor Flange

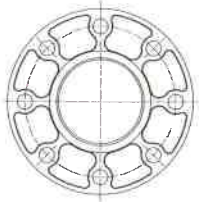
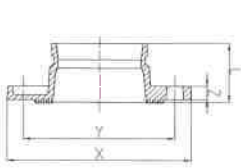

Nominal Size mm/in	Pipe O.D mm/in	Working Pressure PSI/MPa	Dimensions				Bolt/Nut No.-SIZE mm	Certificate
			L mm/in	X mm/in	Y mm/in	Z mm/in		
80 3	88.9 3.500	225 1.6	65 2.559	200 7.87	160 6.30	17 0.67	8-M20	—
100 4	114.3 4.500	225 1.6	70 2.756	225 8.86	185 7.28	19 0.75	8-M20	—
150 165.1	165.1 6.500	225 1.6	70 2.756	305 12.00	260 10.236	21 0.827	12-M22	—

321GJ JIS 20K

Adaptor Flange

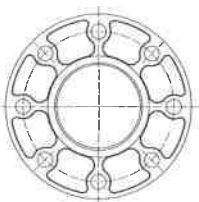
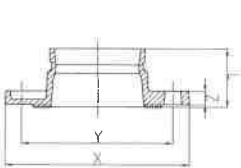

Nominal Size mm/in	Pipe O.D mm/in	Working Pressure PSI/MPa	Dimensions				Bolt/Nut No.-SIZE mm	Certificate
			L mm/in	X mm/in	Y mm/in	Z mm/in		
100 4	114.3 4.500	300 2.0	70 2.756	225 8.86	185 7.28	19 0.75	8-M20	—
150 165.1	165.1 6.500	300 2.0	70 2.756	305 12.00	260 10.236	21 0.827	12-M22	—

Gasket Data



Gasket	Name	Temperature Range	General Service Recommendations	Color Mark
E	EPDM	-34~+110°C (-30~+230° F)	Recommended for hot water service within the specified temperature range plus a variety of dilute acids, oil-free air and many chemical services. UL classified in accordance with ANSI/NSF 61 or cold +86° F (+30°) and hot +180° F (+82°C) potable water service. Not recommended for petroleum service.	Black Green Strip
D	NBR	-29~+82°C (-20~+180° F)	Recommended for petroleum products, air with oil vapors, vegetable and mineral oils within the specified temperature range. Not recommended for hot water services.	Orange Strip
S	Silicone	-40~+177°C (-40~+350° F)	Recommended for high temperature dry air and some high temperature chemical products.	White

ANSI Heavy Hex Nut

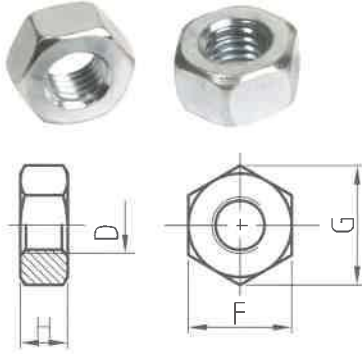

1. Material: SAE J995 2.
2. Thread: ANSI B 1.1-1982, class 2B.
3. Surface Treatment: Zinc electroplated per ASTM B633
CLASS FE/ZN5 TYPE III, thickness $\geq 5 \mu\text{m}$ per class SC1.

d	F		G		H	
	Min	Max	Min	Max	Min	Max
3/8-16UNC	16.99	17.47	19.38	20.17	8.66	9.57
1/2-13UNC	21.59	22.22	24.61	25.65	11.78	12.80
5/8-11UNC	26.19	26.97	29.85	31.16	14.90	16.02
3/4-10UNC	30.78	31.75	35.10	36.65	18.03	19.25
7/8-9UNC	35.41	36.53	40.36	42.16	21.16	22.48

Metric Heavy Hex Nut

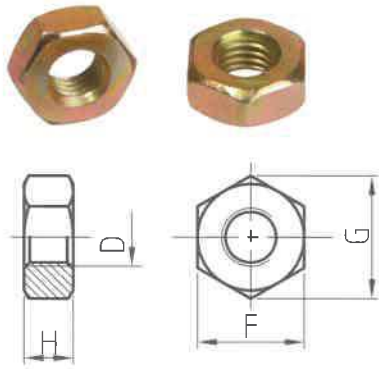

1. Material: ISO 898-2:1992 \ GB/T3098.2-2000 Class 8.
2. Thread: ISO 261, tolerance 6h for M10& M12, 7h for M16 and above.
3. Surface Treatment: Zinc Electroplated followed by a yellow chromate dip per ISO 2081 FE/ZN5, ISO4520 CLASS 1A.

d	F		G	H	
	Min	Max	Min	Min	Max
M10	15.73	16.0	17.7	8.0	8.4
M12	21.16	22.0	23.9	9.34	10.0
M16	23.16	24.0	26.17	14.1	15.9
M20	29.16	30.0	32.95	16.9	19.0
M22	33.0	34.0	37.29	18.1	20.2

Hexagon Flange Nut

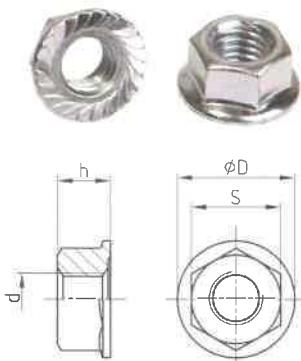

Dimension according to DIN6923.

d	S		D	h	
	Min	Max	Max	Min	Max
M8	12.3	13	17.9	7.6	8
M10	14.73	15.0	21.8	9.64	10
M12	17.73	18.0	26.0	11.57	12.0

ANSI Oval Neck Track Bolt

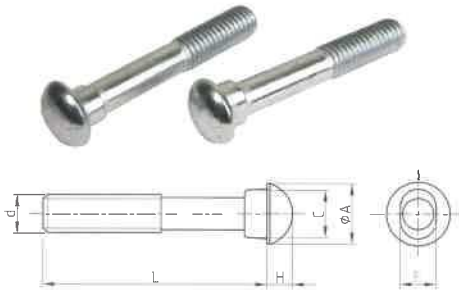

1. Material: SAE J429 5.
2. Thread: UNC thread per ANSI B 1.1 Class 2A.
3. Surface Treatment: Silver chromate electroplated per ASTM B633 CLASS FE/ZN5 TYPE III, thickness $\geq 5 \mu\text{m}$ per class SC1.

d	A	C	F	H	L
3/8-16UNC	19	13.9	9.50	6.0	55/70
1/2-13UNC	22.5	16	12.70	8.0	70/75
5/8-11UNC	27.4	19.8	15.90	10.0	80/85/105
3/4-10UNC	32.5	26.2	19.05	12.0	115/120
7/8-9UNC	37.7	28.8	22.20	14.0	125/140

Metric Oval Neck Track Bolt

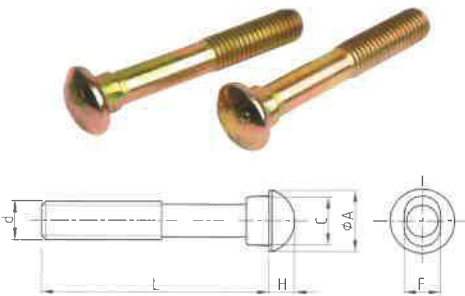

1. Material: ISO 898-1:1992 \ GB/T3098.1-2000 Class 8.8.
2. Thread: ISO metric thread per ISO 261, tolerance 6h.
3. Surface Treatment: Yellow chromate electroplated per ISO 2081 FE/ZN5, ISO4520 CLASS 1A.

d	A	C	F	H	L
M10	18.5	13.5	9.5	5	50/57/63/70/89
M12	23.5	17.5	12.3	8	70/76/82/89/108
M16	29.5	20.5	15.7	10	85/89/95/108
M20	38	27	18.3	12.5	110/115
M22	42.2	31	21.4	14	125/140/150

Hole Diameter of pipe

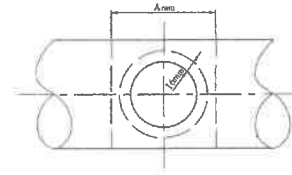

Hole-cutting Machine

Run Nominal Size mm/in	Outlet Nominal Size mm/in	Hole Dia. +3.2,0+0.13,0 mm/in	Run Nominal Size mm/in	Outlet Nominal Size mm/in	Hole Dia. +3.2,0+0.13,0 mm/in	Run Nominal Size mm/in	Outlet Nominal Size mm/in	Hole Dia. +3.2,0+0.13,0 mm/in	
25 1"33.7	10 3/8	23.5 0.925 A89	80 3"68.9	15 1/2	38 1.50 A89	150 159.0 165.1 6"168.3	15 1/2	38 1.50 A89	
	20 3/4			20 3/4					
	25 1			25 1					
	32 1 1/4			32 1 1/4					
32 1 1/4"42.4	10 3/8	30 1.18 A89	100 108.0 4"114.3	40 1 1/2	51 2.00 A102	200 8"219.1 250 10"273.0	40 1 1/2	51 2.00 A102	
	15 1/2			50 2			50 2		
	20 3/4			64 2.50 A114			65 2 1/2 A120		
	25 1			70 2.75 A120			80 3 A140		
40 1 1/2"48.3	10 3/8	30 1.18 A89	125 133.0 139.7 5"141.3	25 1	38 1.50 A89	250 10"273.0	100 108.0/4	38 1.50 A89	
	15 1/2			32 1 1/4			114 4.50 A165		
	20 3/4			40 1 1/2			114 4.50 A165		
	25 1			50 2			114 4.50 A165		
50 2"60.3	15 1/2	38 1.50 A89	125 133.0 139.7 5"141.3	65 2 1/2 A120	38 1.50 A89	250 10"273.0	25 1	38 1.50 A89	
	20 3/4			80 3 A140			32 1 1/4		51 2.00 A102
	25 1			89 3.50 A140			40 1 1/2		51 2.00 A102
	32 1 1/4			89 3.50 A140			50 2		64 2.50 A114
65 2 1/2"73.0 76.1	15 1/2	38 1.50 A89	125 133.0 139.7 5"141.3	80 3 A140	38 1.50 A89	250 10"273.0	65 2 1/2 A120	38 1.50 A89	
	20 3/4			89 3.50 A140			80 3 A140		114 4.50 A165
	25 1			89 3.50 A140			100 108.0/4		114 4.50 A165
	32 1 1/4			89 3.50 A140			100 108.0/4		114 4.50 A165
65 2 1/2"73.0 76.1	15 1/2	38 1.50 A89	125 133.0 139.7 5"141.3	20 3/4	38 1.50 A89	250 10"273.0	100 108.0/4	38 1.50 A89	
	20 3/4			25 1			100 108.0/4		114 4.50 A165
	25 1			32 1 1/4			100 108.0/4		114 4.50 A165
	32 1 1/4			40 1 1/2			100 108.0/4		114 4.50 A165

The outside surface of the pie within 16mm from the hole must be clean and smooth.

Roll Groove Dimensions



Roll Grooving Machine

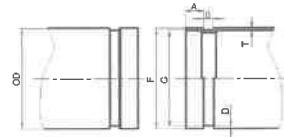

Nominal Size mm/in	Pipe OD		Gasket seat A ±0.76/±0.03 mm/in	Groove Width B ±0.76/±0.03 mm/in	Groove Dia C		Groove Depth D(ref) mm/in	Max Allow Flare Dia F mm/in	Min. Allow wall thickness T mm/in	
	Basic mm/in	Tolerance mm/in			Basic mm/in	Tolerance mm/in				
25 1	33.7 1.327	+0.41 +0.016	-0.68 -0.026	15.88 0.625	7.14 0.281	30.23 1.190	-0.38 -0.015	1.60 0.063	34.5 1.358	1.8 0.071
32 1 1/4	42.4 1.669	+0.50 0.020	-0.60 -0.023	15.88 0.625	7.14 0.281	38.99 1.535	-0.38 -0.015	1.60 0.063	43.3 1.705	1.8 0.071
40 1 1/2	48.3 1.900	+0.44 0.017	-0.52 -0.020	15.88 0.625	7.14 0.281	45.09 1.775	-0.38 -0.015	1.60 0.063	49.4 1.945	1.8 0.071
50 2	80.3 2.375	+0.61 +0.024	-0.61 -0.024	15.88 0.625	8.74 0.344	57.15 2.250	-0.38 -0.015	1.60 0.063	82.2 2.449	1.8 0.071
65 2 1/2	73.0 2.875	+0.74 +0.029	-0.74 -0.029	15.88 0.625	8.74 0.344	69.09 2.720	-0.46 -0.018	1.98 0.078	75.2 2.951	2.3 0.091
85 2 1/2	76.1 3.000	+0.76 +0.030	-0.76 -0.030	15.88 0.625	8.74 0.344	72.26 2.845	-0.46 -0.018	1.99 0.078	77.7 3.059	2.3 0.091
80 3	88.9 3.500	+0.89 +0.035	-0.79 -0.031	15.88 0.625	8.74 0.344	84.94 3.344	-0.46 -0.018	1.98 0.078	90.6 3.567	2.3 0.091
100 4	108.0 4.250	+1.07 +0.042	-0.79 -0.031	15.88 0.625	8.74 0.344	103.73 4.084	-0.51 -0.020	2.11 0.083	109.7 4.319	2.3 0.091
100 4	114.3 4.500	+1.14 +0.045	-0.79 -0.031	15.88 0.625	8.74 0.344	110.08 4.334	-0.51 -0.020	2.11 0.083	116.2 4.575	2.3 0.091
125 5	133.0 5.250	+1.32 +0.052	-0.79 -0.031	15.88 0.625	8.74 0.344	129.13 5.084	-0.51 -0.020	2.11 0.083	134.9 5.311	2.9 0.114
125 5	139.7 5.500	+1.40 +0.055	-0.79 -0.031	15.88 0.625	8.74 0.344	135.46 5.334	-0.51 -0.020	2.11 0.083	141.7 5.579	2.9 0.114
125 5	141.3 5.563	+1.42 +0.056	-0.79 -0.031	15.88 0.625	8.74 0.344	137.03 5.395	-0.56 -0.022	2.13 0.084	143.5 5.650	2.9 0.114
150 6	159.0 6.250	+1.60 +0.063	-0.79 -0.031	15.88 0.625	8.74 0.344	154.50 6.083	-0.56 -0.022	2.16 0.085	161.0 6.339	2.9 0.114
150 6	165.1 6.500	+1.60 +0.063	-0.79 -0.031	15.88 0.625	8.74 0.344	160.8 6.330	-0.56 -0.022	2.16 0.085	167.1 6.579	2.9 0.114
150 6	168.3 6.625	+1.60 +0.063	-0.79 -0.031	15.88 0.625	8.74 0.344	163.96 6.455	-0.56 -0.022	2.16 0.085	170.7 6.720	2.9 0.114
200A 8	216.3 8.516	+1.60 +0.063	-0.79 -0.031	19.05 0.750	11.91 0.469	211.60 8.331	-0.64 -0.025	2.35 0.093	219.8 8.653	2.9 0.114
200 8	219.1 8.625	+1.60 +0.063	-0.79 -0.031	19.05 0.750	11.91 0.469	214.40 8.441	-0.64 -0.025	2.34 0.092	221.5 8.720	2.9 0.114
250A 10	267.4 10.528	+1.60 +0.063	-0.79 -0.031	19.05 0.750	11.91 0.469	262.60 10.339	-0.69 -0.027	2.40 0.095	270.9 10.665	3.6 0.142
250 10	273.0 10.750	+1.60 +0.063	-0.79 -0.031	19.05 0.750	11.91 0.469	268.28 10.562	-0.69 -0.027	2.39 0.094	275.4 10.842	3.6 0.142
300A 12	318.5 12.539	+1.60 +0.063	-0.79 -0.031	19.05 0.750	11.91 0.469	312.90 12.319	-0.76 -0.030	2.77 0.109	322.0 12.677	4.0 0.158
300 12	323.9 12.750	+1.60 +0.063	-0.79 -0.031	19.05 0.750	11.91 0.469	318.29 12.531	-0.76 -0.030	2.77 0.109	326.2 12.842	4.0 0.158
350 14	355.6 14.000	+1.60 +0.063	-0.79 -0.031	23.83 0.938	11.91 0.469	350.04 13.781	-0.76 -0.030	2.77 0.109	359.7 14.16	4.0 0.158
350 14	377.0 14.842	+1.60 +0.063	-0.79 -0.031	23.83 0.938	11.91 0.469	371.44 14.623	-0.76 -0.030	2.77 0.109	379.5 14.941	4.5 0.177
400 16	406.4 16.000	+1.60 +0.063	-0.79 -0.031	23.83 0.938	11.91 0.469	400.84 15.781	-0.76 -0.030	2.77 0.109	410.5 16.16	4.2 0.165
400 16	426.0 16.772	+1.60 +0.063	-0.79 -0.031	23.83 0.938	11.91 0.469	420.46 16.553	-0.76 -0.030	2.77 0.109	428.5 16.870	4.5 0.177
450 18	457.2 18.000	+1.50 +0.063	-0.79 -0.031	25.40 1.000	11.91 0.469	451.64 17.781	-0.76 -0.030	2.77 0.109	461.3 18.16	4.2 0.165
450 18	480 18.897	+1.60 +0.063	-0.79 -0.031	25.40 1.000	11.91 0.469	489 18.465	-0.76 -0.030	2.77 0.109	484.1 19.06	4.2 0.165
500 20	508.0 20.000	+1.60 +0.063	-0.79 -0.031	25.40 1.000	11.91 0.469	502.44 19.781	-0.76 -0.030	2.77 0.109	512.1 20.16	4.8 0.188
500 20	530 20.866	+1.60 +0.063	-0.79 -0.031	25.40 1.000	11.91 0.469	522 20.55	-0.76 -0.030	4.0 0.157	535.1 21.067	5.0 0.197
600 24	609.6 24.000	+1.60 +0.063	-0.79 -0.031	25.40 1.000	12.7 0.500	600.9 23.656	0.76 -0.030	4.35 0.172	614.7 24.20	4.8 0.188
600 24	630 24.803	+1.60 +0.063	-0.79 -0.031	25.40 1.000	12.7 0.500	620.9 24.445	0.76 -0.030	4.55 0.179	635.1 25.00	4.8 0.188

Pressure Ratings and End Loads for Mech Couplings on Steel Pipe



1G Rigid



1GS L/Duty Rigid



1N Reducing

Nom. Size	Pipe O.D	Pipe Sched	Wall Thick.	1G		1GS		1N	
				Roll Grooved		Roll Grooved		Roll Grooved	
				Max.Work Press.	Max.End Load	Max.Work Press.	Max.End Load	Max.Work Press.	Max.End Load
DN/in	mm	(Sch)	mm	Bar/Psi	kN/Lbs	Bar/Psi	kN/Lbs	Bar/Psi	kN/Lbs
25	33.7	40	3.38	35/500	3.0/680	--	--	20/300	1.8/410
		10	2.77	35/500	3.0/680	--	--	20/300	1.8/410
32	42.4	40	3.56	35/500	4.8/1080	--	--	20/300	2.9/650
		10	2.77	35/500	4.8/1080	--	--	20/300	2.9/650
40	48.3	40	3.68	35/500	6.3/1420	--	--	20/300	3.8/850
		10	2.77	35/500	6.3/1420	--	--	20/300	3.8/850
50	60.3	40	3.91	35/500	9.8/2210	--	--	20/300	5.9/1330
		10	2.77	35/500	9.8/2210	--	--	20/300	5.9/1330
65	73	40	5.16	35/500	14.4/3240	--	--	20/300	8.7/1950
		10	3.05	35/500	14.4/3240	--	--	20/300	8.7/1950
65	76.1	--	6.35	--	--	--	--	--	--
		--	5.08	35/500	15.7/3520	--	--	20/300	9.4/2120
		--	3.81	35/500	15.7/3520	--	--	20/300	9.4/2120
80	88.9	40	5.49	35/500	21.4/4810	24/350	15.0/3360	20/300	12.8/2885
		10	3.05	35/500	21.4/4810	24/350	15.0/3360	20/300	12.8/2885
100	114.3	40	6.02	35/500	35.4/7960	24/350	24.7/5560	20/300	21.2/4770
		10	3.05	35/500	35.4/7960	24/350	24.7/5560	20/300	21.2/4770
125	141.3	40	6.55	35/500	54.1/12100	24/350	37.8/8490	20/300	32.4/7290
		10	3.4	35/500	54.1/12100	24/350	37.8/8490	20/300	32.4/7290
150	165.1	--	6.35	35/500	73.8/16610	24/350	51.6/11600	20/300	44.3/9960
		--	5.08	35/500	73.8/16610	24/350	51.6/11600	20/300	44.3/9960
150	168.3	40	7.11	35/500	76.7/17260	24/350	53.6/12000	20/300	46.0/10340
		10	3.4	35/500	76.7/17260	24/350	53.6/12000	20/300	46.0/10340
200	219.1	40	8.18	31/450	116.9/26280	24/350	90.8/20430	--	--
		30	7.04	31/450	116.9/26280	24/350	90.8/20430	--	--
		10	4.77	20/300	77.8/17500	24/350	90.8/20430	--	--
250	273	40	9.27	28/400	163.8/36800	--	--	--	--
		30	7.8	20/300	121.0/27210	--	--	--	--
		10	4.77	20/300	121.0/27210	--	--	--	--
300	323.9	40	10.31	28/400	230.6/51880	--	--	--	--
		STD	9.53	20/300	170.3/38280	--	--	--	--
		30	6.35	20/300	170.3/38280	--	--	--	--
		10	4.77	20/300	170.3/38280	--	--	--	--

Pressure Ratings and End Loads for Mech Couplings on Steel Pipe



1N Flexible



1NH Heavy Duty Flexible



321 Flange

Nom. Size	Pipe O.D	Pipe Sched	Wall Thick.	1N		1NH		321	
				Roll Grooved		Roll Grooved		Roll Grooved	
				Max.Work Press.	Max.End Load	Max.Work Press.	Max.End Load	Max.Work Press.	Max.End Load
DN/in	mm	(Sch)	mm	Bar/Psi	kN/Lbs	Bar/Psi	kN/Lbs	Bar/Psi	kN/Lbs
25	33.7	40	3.38	35/500	3.0/680	--	--	--	--
		10	2.77	35/500	3.0/680	--	--	--	--
32	42.4	40	3.56	35/500	4.8/1080	--	--	--	--
		10	2.77	35/500	4.8/1080	--	--	--	--
40	48.3	40	3.56	35/500	6.3/1420	--	--	16/225	3.2/710
		10	2.77	35/500	6.3/1420	--	--	16/225	3.2/710
50	60.3	40	3.91	35/500	9.8/2210	52/750	14.8/3320	16/225	4.4/1000
		10	2.77	35/500	9.8/2210	35/500	9.8/2210	16/225	4.4/1000
65	73	40	5.16	35/500	14.4/3240	52/750	21.6/4860	20/300	5.9/1330
		10	3.05	35/500	14.4/3240	35/500	14.4/3240	20/300	5.9/1330
65	76.1	--	6.35	--	--	--	--	--	--
		--	5.08	35/500	15.7/3520	52/750	23.5/5280	16/225	7.1/1590
		--	3.81	35/500	15.7/3520	35/500	15.7/3530	16/225	7.1/1590
80	88.9	40	5.49	35/500	21.4/4810	52/750	32.1/7210	16/225	9.6/2165
		10	3.05	35/500	21.4/4810	35/500	21.4/4800	16/225	9.6/2165
100	114.3	40	6.02	35/500	35.4/7960	52/750	53.0/11900	16/225	15.9/3580
		10	3.05	35/500	35.4/7960	35/500	35.4/7950	16/225	15.9/3580
125	141.3	40	6.55	35/500	54.1/12100	52/750	81.0/18200	20/300	31.3/7035
		10	3.4	35/500	54.1/12100	31/450	48.6/10930	20/300	31.3/7035
150	165.1	--	6.35	35/500	73.8/16610	52/750	110.6/24800	16/225	33.2/7460
		--	5.08	35/500	73.8/16610	31/450	66.4/14930	16/225	33.2/7460
150	168.3	40	7.11	35/500	76.7/17260	52/750	115.0/25800	16/225	34.5/7750
		10	3.4	35/500	76.7/17260	31/450	68.9/15500	16/225	34.5/7750
200	219.1	40	8.18	31/450	116.9/26280	52/750	194.8/43800	16/225	58.4/13140
		30	7.04	31/450	116.9/26280	35/500	130.0/29250	16/225	58.4/13140
		10	3.76	20/300	77.8/17500	20/300	77.8/17500	16/225	58.4/13140
250	273	40	9.27	20/300	121.0/27210	--	--	16/225	90.8/20410
		30	6.35	20/300	121.0/27210	--	--	16/225	90.8/20410
		10	4.19	20/300	121.0/27210	--	--	16/225	90.8/20410
300	323.9	40	10.31	20/300	170.3/38280	--	--	16/225	127.7/28710
		STD	9.53	20/300	170.3/38280	--	--	16/225	127.7/28710
		20	6.35	20/300	170.3/38280	--	--	16/225	127.7/28710
		10	4.57	20/300	170.3/38280	--	--	16/225	127.7/28710

Installation Instruction For Rigid & Flexible Coupling



1. Pipe preparation

Check pipe end for proper groove dimensions and to assure that pipe end is free of indentations and projections that would prevent proper sealing.



2. Lubricate gasket

Check gasket to be sure it's compatible for the intended service. Apply thin lubricant to the outside and sealing lips of the gasket.



3. Gasket installation

Slip the gasket over one pipe, making sure the gasket lip does not over-hang the pipe end.



4. Alignment

After aligning two pipe ends together, pull the gasket into position, centering between the grooves on each pipe. The gasket should not extend into the groove on either pipe.



5. Housing installation

Remove one bolt&nut and loosen the other nut. Place one housing over the gasket, making sure the housing keys fit into the pipe grooves. Swing the other housing over the gasket and into the grooves on both pipes. Re-insert the bolt and connect two housings.



6. Tighten nuts

Firstly hand tighten nuts and make sure oval neck bolt completely fills into bolt hole. Then securely tighten nuts alternatively and equally to the specified bolt torque by using spanner.



7 a. Assembly completed- Rigid Coupling

For Rigid Coupling, keep the gaps at bolt pads evenly spaced. Gaskets can't be seen visually.



7 b. Assembly completed- Flexible Coupling

For Flexible Coupling, two housings should be iron to iron connected. Gaskets can't be seen visually.

Caution

Proper torquing of bolts is required to obtain specified performance.

- Over torquing the bolts may result in damage to the bolt and / or casting which could result in pipe joint separation.
- Under torquing the bolts may result in lower pressure retention capabilities, lower bend load capabilities, joint leakage and pipe joint separation. Pipe joint separation may result in significant property damage and serious injury.

Specified Bolt Torque

ANSI BOLTS		
Bolt Size	Specified Bolt Torque	
	Lbs-Ft.	N.m
3/8	30-45	40-60
1/2	80-100	110-135
5/8	100-130	135-175
3/4	130-180	175-245
7/8	180-240	245-325

Installation Instruction For Threaded & Grooved Mechanical Tee



1. Pipe preparation

Clean the gasket sealing surface within 16mm of the hole and visually inspect the sealing surface for defects that may prevent proper sealing of the gasket. Don't drill the hole on weld line.



2. Remove burrs

If any burrs or slug exists at the pipe hole, please remove them before assembly, to protect the gasket and avoid leakage.



3. Gasket installation

Insert the gasket into outlet housing making sure the tab in the gasket line up with the tab recesses in the housing. Align outlet housing over the pipe hole making sure that the locating collar is in the pipe hole.



4. Alignment

Align the strap around the pipe, insert the bolts and tighten the nuts finger tight.



5. Tighten nuts

Alternatively and evenly tighten the nuts to the specified bolt torque.



6. Assembly completed

There should be even gaps on two sides between upper and lower housings.

Caution

Proper torquing of bolts is required to obtain specified performance.

- Over torquing the bolts may result in damage to the bolt and / or casting which could result in pipe joint separation.
- Under torquing the bolts may result in lower pressure retention capabilities, lower bend load capabilities, joint leakage and pipe joint separation. Pipe joint separation may result in significant property damage and serious injury.

Specified Bolt Torque

ANSI BOLTS		
Bolt Size	Specified Bolt Torque	
	Lbs-Ft.	N.m
3/8	30-45	40-60
1/2	80-100	110-135
5/8	100-130	135-175
3/4	—	—
7/8	—	—

Installation Instruction For U-Bolt Mechanical Tee



1. Pipe preparation

Clean the gasket sealing surface within 16mm of the hole and visually inspect the sealing surface for defects that may prevent proper sealing of the gasket. Don't drill the hole on weld line.



2. Remove burrs

If any burrs or slug exists at the pipe hole, please remove them before assembly, to protect the gasket and avoid leakage.



3. Gasket installation

Insert the gasket into outlet housing properly. Align outlet housing over the pipe hole making sure that the locating collar is in the pipe hole.



4. Alignment

Attach the U-bolt from the other side and tighten the nuts finger tight.



5. Tighten nuts

Alternatively and evenly tighten the nuts to the specified bolt torque.

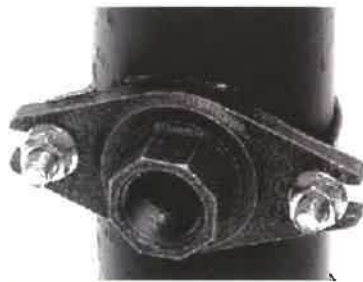

6. Assembly completed

Assembly completed.

Caution

Proper torquing of bolts is required to obtain specified performance.

- Over torquing the bolts may result in damage to the bolt and / or casting which could result in pipe joint separation.
- Under torquing the bolts may result in lower pressure retention capabilities, lower bend load capabilities, joint leakage and pipe joint separation. Pipe joint separation may result in significant property damage and serious injury.

Specified Bolt Torque

ANSI BOLTS		
Bolt Size	Specified Bolt Torque	
	Lbs-Ft.	N.m
3/8	20-30	30-40
1/2	80-100	110-135
5/8	100-130	135-175
3/4	—	—
7/8	—	—

Installation Instruction For Grooved Flange



1. Pipe preparation

Check pipe end for proper groove dimensions and to assure that pipe end is free of indentations and projections that would prevent proper sealing.



2. Lubricate gasket

Check gasket to be sure it's compatible for the intended service. Apply thin lubricant to the outside and sealing lips of the gasket.



3. Gasket installation

Slip the gasket over pipe end, with the gasket opening side towards "A". Make sure the gasket sealing lip is even with pipe end.



4. Housing installation

Remove bolts and nuts, place two housings over the gasket, making sure the housing keys fit into the pipe grooves. Re-insert the bolts and hand tighten the nuts.



5. Tighten nuts

Securely tighten nuts alternatively and equally to the specified bolt torque by using spanner.

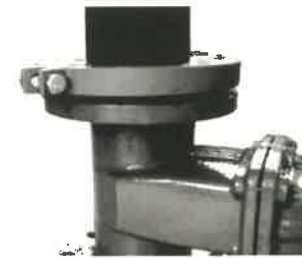

6. Connect mating flange

Align flange bolt holes with mating flange (or valve) bolt holes. Insert a standard flange bolt through bolt hole and hand tighten a nut. Insert another bolt opposite the first and hand tighten a nut. Continue this until all bolt holes are fitted. Tighten nuts evenly to specified bolt torque, so flange faces remain parallel. Assembly completed.

Caution

Proper torquing of bolts is required to obtain specified performance.

- Over torquing the bolts may result in damage to the bolt and / or casting which could result in pipe joint separation.
- Under torquing the bolts may result in lower pressure retention capabilities, lower bend load capabilities, joint leakage and pipe joint separation. Pipe joint separation may result in significant property damage and serious injury.

Specified Bolt Torque

ANSI BOLTS		
Bolt Size	Specified Bolt Torque	
	Lbs-Ft.	N.m
M10	30-45	40-60
M12	80-100	110-135
M16	—	—
M20	—	—
M22	—	—
M24	—	—

Flexible Coupling

1. A flexible coupling accommodates pipe deflection and or non-alignment as below:
 If nominal diameter $<DN200$, deflection angle is $\geq 1^\circ$; If nominal diameter $\geq DN200$, deflection angle is $\geq 0.5^\circ$ but $< 1^\circ$.

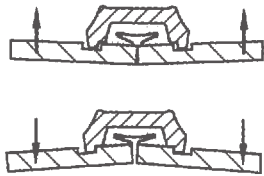

2. The C-shaped rubber gasket provides excellent self-sealing capabilities in both low and high pressure service as well as under certain vacuum conditions.

3. The design and construction of the coupling with elastomeric gaskets can provide significant noise and vibration absorption as well as seismic stress.

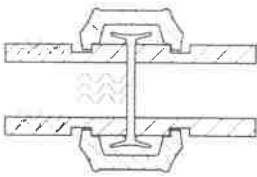

4. With the removal of just a few bolts you can easily access the system for cleaning, maintenance, changes or system expansion.

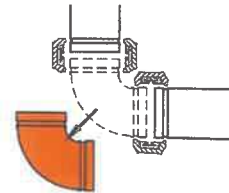

5. Couplings are non-directive and pipe can be rotated 360° during installation.

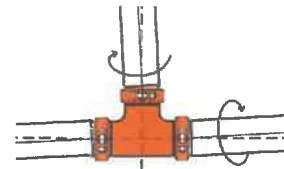

6. Coupling keys engage the full circumference of the grooves and provide significant pressure and end load restraint against pipe movement from internal and external forces.

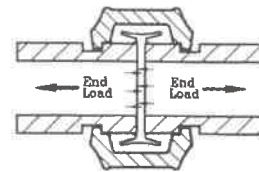

Rigid Coupling

1. The T&G mechanism in combination with a slightly shortened key diameter provides a mechanical and frictional interlock resulting in a rigid joint which reduces undesired angular movement.

2. The built-in teeth on the coupling grip the groove shoulder and serve to reduce linear movement.

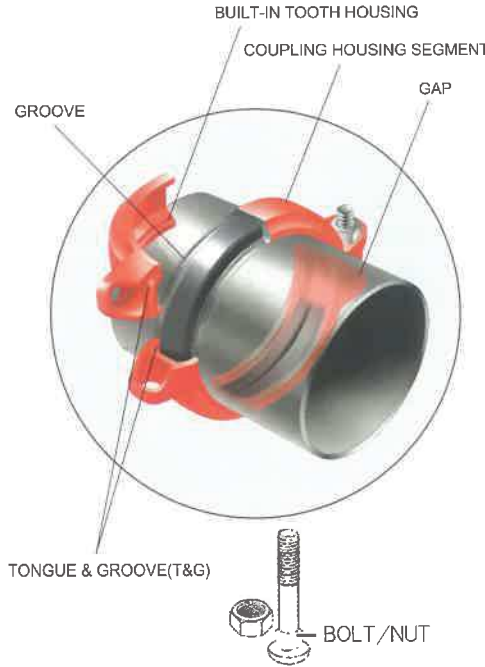

3. The T&G mechanism features a slight offset at the foot of the coupling halves which serve to protect the gasket from exposure.

4. With the T&G style coupling no metal-to-metal contact of the bolt pads is required. You will normally see a 1/16" - 1/8" (1.6mm to 3.2mm) gap between the bolt pads when installed.

Mechanical Tee Connection

The Mechanical Tee (3J, 3G, 3L) provide for a fast and easy grooved or threaded branch outlet and eliminate the need for welding or the use of a reducing tee and couplings. Simply cut a hole to the specified size at the expected location and fasten the mechanical tee to the pipe with the nuts and bolts provided. As the housing bolts are tightened, the pressure responsive gasket forms a leak-tight seal.

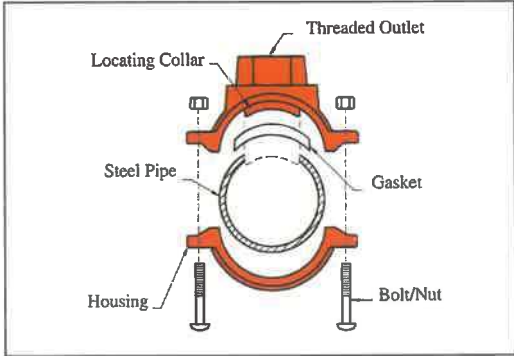

Movement

Each flexible design coupling can provide for pipe system movement up to the design maximum for the specific size and type coupling being utilized. Movement is possible in the coupling due to two factors: (1) designed-in clearance between the key of the coupling and the groove diameter and groove width, and (2) the gap between pipe ends joined by the coupling.

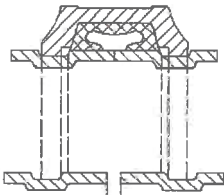

1.Linear Movement

Linear movement is accommodated within the coupling by allowing the pipe ends to move together or apart in response to pressure thrusts and temperature changes. The available linear movement provided by couplings is shown below:

size	1-1¼ (25-32MM)	1½-12 (40-300MM)
movement	0-4.0MM	0-6.4MM

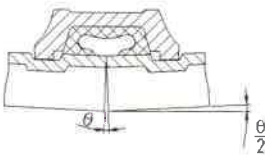

2.Angular Movement

Designed-in clearances allow limited deflection of the pipe joint within the coupling, without introducing eccentric loads into the coupling joint.

The maximum available angular movement of coupling joints is shown in the performance data for each coupling type. The amount of angular flexibility varies for each coupling size and type. For design purposes the published figures should be reduced by the below listed factors to account for pipe, groove and coupling tolerances.

size	1-3(IN)	4-12(IN)
Design factor	Reduce to 50%	Reduce to 75%

Flexible Couplings: Linear Movement and Angular Movement

Size		Cut			Roll Groove		
		Linear Movement	Angular Movement		Linear Movement	Angular Movement	
Inch	mm	mm	Degree	mm/m	mm	Degree	mm/m
1	33.7	2	2°-45'	48	1	1°-22'	24
1 1/4	42.4	2	2°-10'	38	1	1°-05'	19
1 1/2	48.3	3.2	1°-54'	33	1.6	0°-57'	16.5
2	60.3	3.2	1°-31'	26	1.6	0°-45'	13
2 1/2	73	3.2	1°-27'	25	1.6	0°-43'	12.5
2 1/2	76.1	3.2	1°-12'	21	1.6	0°-36'	10.5
3	88.9	3.2	1°-02'	18	1.6	0°-31'	9
4	108	3.2	1°-51'	32	1.6	0°-55'	16
4	114.3	3.2	1°-36'	28	1.6	0°-48'	14
5	133	3.2	1°-41'	30	1.6	0°-50'	15
5	139.7	3.2	1°-19'	23	1.6	0°-37'	11.5
5	141.3	3.2	1°-03'	18	1.6	0°-30'	9
6	159	3.2	1°-18'	23	1.6	0°-39'	11.5
6	165.1	3.2	1°-05'	20	1.6	0°-35'	10
6	168.3	3.2	1°-05'	19	1.6	0°-32'	9.5
8	219.1	3.2	0°-50'	15	1.6	0°-25'	7.5
10	273	3.2	0°-40'	12	1.6	0°-20'	6
12	323.9	3.2	0°-34'	10	1.6	0°-18'	5

Movement -Application

• Thermal stress

Thermal stress is caused by changes in temperature, resulting in either expansion or contraction. When designing a system you must allow for this thermal movement. To determine the appropriate number of flexible couplings to allow for this thermal movement please refer to the following.

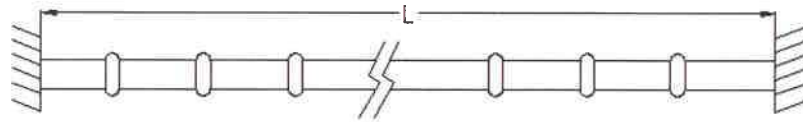

Example:

- 4" straight steel pipe, 30m long
- Anchored on both ends
- Minimum temperature (during installation) = 5°C
- Maximum working temperature = 55°C

From the thermal expansion table, we know the overall pipeline length will increase by 18mm (0.71"). You can also use Formula 1 or Table 3 to find the amount of thermal expansion. We want to know the number of couplings that are required to address this thermal movement problem.

The allowed movement of a 4" flexible coupling is :

Movement range x Adjustment = Allowed movement

$$4.3\text{mm} \times 75\% = 3.2\text{mm}$$

The appropriate number of coupling is:

Thermal expansion / Allowed movement = Number of couplings

$$18\text{mm} / 3.2\text{mm} = 5.6$$

Conclusion:

The appropriate number of coupling is 6.

• Thermal Expansion

Temperature difference (°C)	Pipe length (m)					
	1	5	10	20	30	40
	Thermal Expansion(mm)					
1	0.012	0.06	0.12	0.24	0.36	0.48
5	0.06	0.3	0.6	1.2	1.8	2.4
10	0.12	0.6	1.2	2.4	3.6	4.8
20	0.24	1.2	2.4	4.8	7.2	9.6
30	0.36	1.8	3.6	7.2	11	15
40	0.48	2.4	4.8	9.6	14	20
50	0.6	3	6	12	18	24
60	0.72	3.6	7.2	14	22	29
70	0.84	4.2	8.4	17	25	34
80	0.96	4.8	9.6	19	29	39

Thermal Expansion Formula 1

$$\lambda = \alpha \times L \times T$$

λ : Thermal Expansion

α : Linear Expansion

coefficient for steel

L : Pipe length

T : Temperature difference

Riser Design

Risers assembled with Flexible couplings are generally installed in either of two ways. In the most common method, the pipe ends are butted together within the coupling joint. Note that when installing risers, the gasket is first placed onto the lower pipe and rolled back away from the pipe end prior to positioning the upper pipe. Anchoring of the riser may be done prior to pressurization with the pipe ends butted or while pressurized, when, due to pressure thrust, the pipe ends will be fully separated.

An alternative method or riser installation is to place a metal spacer of a predetermined thickness, between the pipe ends when an additional length of pipe is added to the riser stack. The upper pipe length is anchored, the spacer removed and the coupling is then installed. This method creates a predetermined gap at each pipe joint which can be utilized in pipe systems where thermal movement is anticipated and in systems with rigid (threaded, welded, flanged) branch connections where shear forces due to pressure thrust could damage the rigid connections.

The following examples illustrate methods of installing commonly encountered riser designs.



Picture 1

• Risers without Branch Connections

Install the riser with the pipe ends butted.

Locate an anchor at the base of the riser (A) to support the total weight of the pipe, couplings and fluid. Provide pipe guides on every other pipe length, as a minimum, to prevent possible deflection of the pipe line at the coupling joints as the riser expands due to pressure thrust or thermal growth. Note that no intermediate anchors are required.

When the system is pressurized the pipe stack will “grow” due to pressure thrust which causes maximum separation of pipe ends within the couplings. The maximum amount of stack growth can be predetermined (see Linear Movement). In this example the pipe length “L” at the top of the riser must be long enough to permit sufficient deflection (see Angular Movement) to accommodate the total movement “M” from both pressure thrust and thermal gradients.

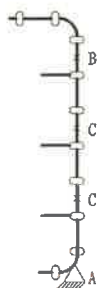

Picture 2

• Risers with Branch Connections

Install the riser with the predetermined gap method. Anchor the pipe at or near the base with a pressure thrust anchor “A” capable of supporting the full pressure thrust, weight of pipe and the fluid column. Anchor at “B” with an anchor capable of withstanding full pressure thrust at the top of the riser plus weight of pipe column. Place intermediate anchors “C” as shown, between anchors “A” and “B”. Also place intermediate clamps at every other pipe length as a minimum.

When this system is pressurized, the pipe movement due to pressure thrust will be strained and there will be no shear forces acting at the branch connections.

• **Misalignment & Deflections**

The angular movement capability of the flexible coupling permits the assembly of pipe joints where the piping is not properly aligned . At least two couplings are required to provide for lateral pipe misalignment . Deflection (longitudinal misalignment) may be accommodated within a single coupling as long as the angle of deflection does not exceed the value shown in the coupling performance data for the particular size and coupling type .

A pipe joint that utilizes the angular deflection capability of the coupling will react to pressure and thermal forces dependent upon the manner in which it is restrained . An unrestrained joint will react to these forces by straightening, thus reducing, if not eliminating, the deflection at the joint . If joint deflection has been designed into the pipe layout and must be maintained, then sufficient anchors must be provided to resist the lateral forces and hold the joint in the deflected condition .

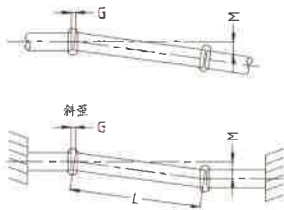

The amount of deflection from pipe run centerline can be calculated utilizing the following equations:

$$M=L \text{ Sin}\theta$$

$$\theta=\text{Sin}^{-1} (G\div D)$$

$$M= (G\div D) \times L$$

Where:

M = Misalignment (inches)

G = Maximum Allowable Pipe End Movement (Inches) as shown under “Performance Data” (Value to be reduced by Design Factor)

θ = Maximum Deflection (Degrees) from centerline as shown under “Performance Data” (Value to be reduced by Design Factor)

D = Pipe Outside Diameter (Inches)

L = Pipe Length (Inches)

• **Curve Layout**

Utilizing the angular deflection at each coupling joint curves may be laid out using straight pipe lengths and Couplings.

This example shows how to calculate the curve radius, required pipe lengths, and number of required couplings.

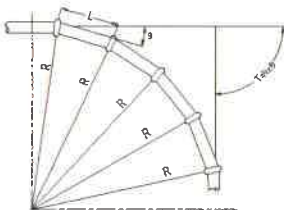

$$R = L / (2 \times \text{Sin}(\theta/2))$$

$$L = 2 \times R \times \text{Sin}(\theta/2)$$

$$N = T / \theta$$

WHERE:

N = Number of Couplings

R = Radius of Curve (feet)

L = Pipe Length (feet)

θ= Deflection from centerline (Degrees) of each Coupling

(See coupling performance data, value to be reduced by Design Factor)

T = Total Angular Deflection of all Couplings.

Anchoring and Supports

When designing the hangers, supports and anchors for a grooved end pipe system, the piping designer must consider certain unique characteristics of the grooved type coupling in addition to many universal pipe hanger and support design factors. As with any pipe system, the hanger or support system must provide for

- 1) the weight of the pipe, couplings, fluid and pipe system components;
- 2) reduce stresses at pipe joints; and
- 3) permit required pipe system movement to relieve stress.

The following chart shows the maximum span between pipe hangers, supports and anchors.

Max. Span between Supports (steel pipe)

Nominal Size (mm)		15	20	25	32	40	50	70	80	100	125	150	200	250	300
Max. Span Between Supports (m)	Insulating Pipe	2	2.5	2.5	2.5	3	3	4	4	4.5	6	7	7	8	8.5
	Non-insulating Pipe	2.5	3	3.5	4	4.5	5	6	6	6.5	7	8	9.5	11	12

Movement capability of couplings-expansion and contraction joints

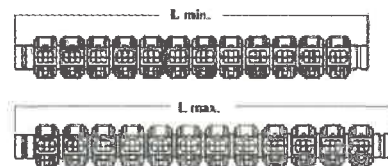

Nominal Size	Pipe O.D. (mm)	Maximum Allowable Movement (mm)	L min. (mm)	L max. (mm)	Number of Couplings	Filled With Water Pressure
1	33.7	45	617	662	10	300
1¼	42.4	45	617	662	10	300
1½	48.3	45	617	662	10	300
2	60.3	45	617	662	10	300
2½	73.0	45	617	662	10	300
76.1	76.1	45	617	662	10	300
3	88.9	45	617	662	10	300
4	114.3	47	503	550	7	300
139.7	139.7	47	503	550	7	300
5	141.3	47	503	550	7	300
165.1	165.1	52	503	550	7	300
6	168.3	52	591	643	7	300
8	219.1	52	591	643	7	300
10	273.0	52	591	643	7	300
12	323.9	52	591	643	7	300

Engineering Test

No.	Item	Standard Requirements
1	Vacuum Test	Grooved couplings, grooved reducing couplings, grooved split flanges, mechanical tees, and plain end couplings shall be able to withstand the effects of vacuum conditions encountered when sprinkler systems are drained. Samples of each nominal size and style of gasketed coupling and fitting shall be subjected to an internal vacuum of 25 in-Hg (85 kPa) for a duration of 5 minutes. Following the vacuum test, the test assembly shall be pneumatically pressurized from zero to 50 psi (345 kPa) while submerged in a water bath. There shall be no leakage or permanent deformation as a result of this test.
2	Hydrostatic Strength Test	All items shall be able to withstand an internal hydrostatic pressure equal to three-five times the rated working pressure without cracking, rupture, or permanent distortion. The test shall be conducted for a duration of 1 minute. (Test Size ≤6" , Five time; 8" -10" , 4time; ≥12" , 3times)
3	Air Leakage Test	The coupling assembly shall be pressurized with air to 3 bar +0.5/-0 bar. The assembly shall be immersed in water to establish that there is no visible leakage
4	Moment Test	The moment resistance shall be demonstrated while the test assembly is internally pressurized to the rated working pressure. Then a force was applied to the test assembly. There shall be no leakage, cracking, or fitting or coupling pull-off as a result of this test.
5	Hot Gasket Test	Standard gaskets shall be assembled to short lengths of pipe, and subjected to 275 ° F (135 ° C) for a duration of 45 days. After exposure, the test assembly shall be submerged in a water bath and subjected to an air under water leakage test from zero to 50 psi (0 to 345 kPa) in order to evaluate for leakage. After the air under water testing is completed, the test assembly shall be disassembled and the gasket shall not crack when squeezed together from any two diametrically opposite points, or twisted into a figure-eight shape. The gasket shall then be visually inspected for signs of cracking, tearing, or excessive degradation as a result of this test.
6	Cold Gasket Test	The low temperature exposure shall consist of -40 ° F (-40 ° C) air exposure for 4 days. After exposure, the assembly while submerged in -40 ° F (-40 ° C) antifreeze, shall be pneumatically pressurized from 0 to 50 psi (0 - 345 kPa). No leakage shall occur. The assembly shall then be allowed to warm to ambient temperature and then be disassembled. The gasket, after removal from the assembly, shall not crack when squeezed together from any two diametrically opposite points, or twisted into a figure eight shape.
7	Flame test	The test shall be conducted in a room free from air draught. The test joint is mounted, U-bent on the test apparatus and filled with water. The angle corresponds to the angle documented as a result of the test Subsequently the test joint is drained. The fuel pan is placed centrally below the pipe joint Fuel is filled into the pan and the fuel is ignited, Burning time 5 min for nominal diameters < DN 100; 8 min for nominal diameters ≥ DN 100 For reducer couplings the dimension of the smaller nominal diameter shall apply for the determination of the burning time. The flame shall be extinguished immediately once the burning time has expired (5 min or 8 min) and the test joint shall be cooled down. For cooling the test joint is immediately sprayed with water until steam formation is no longer visible, but at least for 3 min. The test joint is then filled completely with water and exposed to a test pressure which corresponds to the maximum permissible pressure and is checked visibly for leaks. Water may leak in form of drops, however, not in form of flowing water or a water spray. The test joint is then pressure relieved (force and internal pressure).
8	Cycling Pressure Resistance (Water Hammer Test)	Prior to the cycling, assemblies shall be subjected to a hydrostatic strength test to the rated working pressure, 175 psi (1205 kPa) minimum, for a duration of 5 minutes. Without leakage or cracking. Assemblies shall then be subjected to 20,000 cycles from zero pressure to the rated working pressure, 175 psi (1205 kPa) minimum. After cycling, the test assembly shall be tested Hydrostatic Strength and maintain 5minutes without leakage and cracking.

Engineering Test

No.	Item	Standard Requirements
9	Friction Loss Determination	The construction and installation of the coupling or fitting shall be such that obstruction to the passage of water through the coupling or fitting body is minimal. The loss in pressure through the coupling or fitting shall not exceed 5.0 psi (35 kPa) at a flow producing a velocity of 20 ft/s (6.1 m/s) in Schedule 40 steel pipe of the same nominal diameter as the coupling or fitting.
10	Leakage Test - Assembly without Gasket	Leakage from a gasket-less coupling assembly or fitting shall not exceed that of an operating sprinkler head whose discharge coefficient (K-factor) is 5.3 to 5.8 gal/min{(psi) ^{1/2} } [76 - 84 L/min{(bar) ^{1/2} }. This test is for nominal pipe sizes normally associated with over-head piping, less than or equal to 12 in. NPS (300 mm).
11	Torsion test	This test relates to pipe joints ≤ DN 40 only. The test joint is filled with water and exposed once to the maximum permissible pressure and is then pressure relieved again. Subsequently the test joint is fixed on one pipe end and an increasing torque is applied to the other pipe end. At the pressure-less test joint the pipe joint shall be able to transmit a torque of up to 80 Nm from one pipe end to the other pipe end without any torsion of the pipe ends against each other.
12	Flexibility Test for Flexible Fittings	With the assembly pressurized to its rated pressure, a bending moment is to be applied to deflect the joint to the maximum angle specified by the manufacturer, while not less than 1 degree for nominal pipe diameters less than 8 inches (203.2 mm) or 0.5 degrees for 8 inches (203.2 mm) and larger. Observations are to be made for leakage or pipe damage.
13	Seismic Evaluation	In order to evaluate the use of grooved couplings in Earthquake zones 50 through 500 years, test assemblies utilizing flexible couplings and short lengths of steel pipe, in the same nominal size, will be subjected to cyclic testing. The test will deflect the assembly to the manufacturer's maximum recommended angle in the forward and reverse direction for a total 15 cycles with the internal pressure equal to the rated working pressure. There shall be no leakage, cracking, or rupture as a result of this test.
14	Lateral Displacement	The coupling shall not leak during any of the tests, within the manufacturer's stated limitations for angular deflection or lateral displacement of associated pipework.
15	Hydrostatic fluctuation pressure test	The coupling assembly shall be pressurized with water to a gauge pressure of 10 bar ±1 bar for 2min, +30s/-0s to establish a datum. The assembly shall then be drained before being subjected to the greatest vacuum attainable to a maximum of 600mm a/mercury or -0.8bar +0bar/-0.1 bar for 2min +30s/-0s, and allowed to return to atmospheric pressure in not less than 5s. The assembly shall then be pressurized with water to 10 bar ±1 bar for 2 min +30s/-0s. The assembly shall be examined for leakage throughout the test. The relative movement of each pipe shall be recorded at the greatest vacuum and at each pressure. There shall be no leakage.
16	Fire Test	If a gasketed pipe coupling or fitting employs non-ferrous materials for its substantial structural components, or if in the judgment of FM Approvals, the design is otherwise suspect with respect to fire resistance, a fire test shall be conducted. A representative size assembled joint without a gasket shall be exposed to a 1000 ° F (538 ° C) fire environment for 5 minutes. The assembly shall be dry for the duration of this exposure. Immediately after the exposure, a water flow shall be introduced through the joint and sustained until the assembly is cool to the touch. No cracking or distortion of any component of the coupling or fitting shall occur. The coupling or fitting shall then be disassembled and the gasket installed. After reassembly, the joint shall be hydrostatically tested, as described in to the hydrostatic test.



東成五金有限公司
TUNG SHING HARDWARE CO., LTD.

寫字樓：九龍觀塘成業街 16 號怡生工業中心 C 座 11 樓
電話：(852) 2626 9983 傳真：(852) 2626 9357
門市部：九龍旺角新填地街 249-253 號地舖
九龍大角咀福全街 17-19 號福康大樓地下 J 舖
貨倉部：九龍油塘灣四山街 14 號大益貨倉地庫
Website：www.tungshinghardware.com.hk

MECH FLOW SUPPLIES

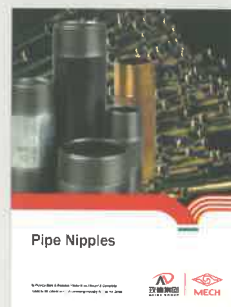
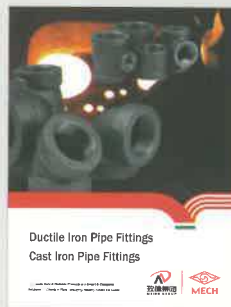
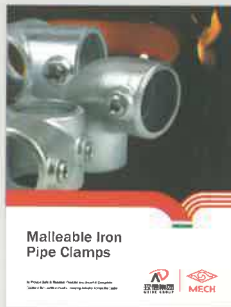
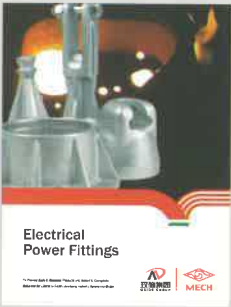
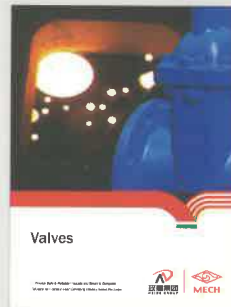
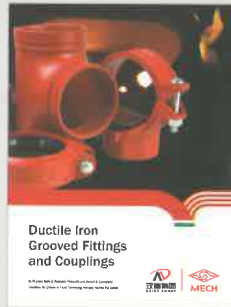
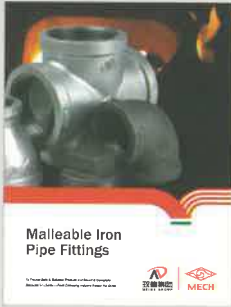

JINAN MEIDE CASTING CO., LTD.

Address: Meide Science & Technology Park,
Industrial Park Pingyin, Jinan, China 250400
Phone: (86)531 87879384 87885036 87885067
Fax: (86)531 87879387
Email: info@meide-casting.com
Http://www.meide-casting.com

